

Single-Phase / 3-Phase Digital Power Controllers



DPU1 / DPU3 Series PRODUCT MANUAL

For your safety, read and follow the considerations written in the instruction manual, other manuals and Autonics website.

The specifications, dimensions, etc. are subject to change without notice for product improvement. Some models may be discontinued without notice.

Features

- High speed and high accuracy by digital control using high speed CPU
- Various controls
 - Phase control, feedback control (constant voltage/constant current/constant power)
 - Zero crossing cycle control (fixed/variable cycles)
 - Zero crossing ON/OFF control
- Improved maintainability with built-in fast-acting fuse and easy fuse replacement
- Communication output model: RS485 (Modbus RTU)
- Various control inputs and DI inputs
 - Control input: analog (current, voltage), ON/OFF (voltage pulse, no voltage), communication (RS485), potentiometer
 - DI input: AUTO/MAN switching, RUN/STOP switching, Reset, output holding, SP designation (6 setting points can be customized)
- Various alarm output
 - Overcurrent, overvoltage, fuse break, heat sink overheat, device fault, heater break (partial heater break detection), phase loss alarm
- Improved convenience by separating operation part
- Applicable load
 - Supercantal, platinum, molybdenum, carbon, halogen lamps, chrome, nickel, etc.

Safety Considerations

- Observe all 'Safety Considerations' for safe and proper operation to avoid hazards.
- ⚠ symbol indicates caution due to special circumstances in which hazards may occur.

⚠ Warning Failure to follow instructions may result in serious injury or death.

- 01. Fail-safe device must be installed when using the unit with machinery that may cause serious injury or substantial economic loss. (e.g. nuclear power control, medical equipment, ships, vehicles, railways, aircraft, combustion apparatus, safety equipment, crime/disaster prevention devices, etc.)**
Failure to follow this instruction may result in personal injury, economic loss or fire.
- 02. Do not use the unit in the place where flammable/explosive/corrosive gas, high humidity, direct sunlight, radiant heat, vibration, impact or salinity may be present.**
Failure to follow this instruction may result in explosion or fire.
- 03. Install on a device panel, and ground separately.**
Failure to follow this instruction may result in fire or electric shock.
- 04. Do not connect, repair, or inspect the unit while connected to a power source.**
Failure to follow this instruction may result in fire or electric shock.
- 05. Do not disassemble or modify the unit.**
Failure to follow this instruction may result in fire or electric shock.
- 06. Check 'Connections' before wiring.**
Failure to follow this instruction may result in fire.

⚠ Caution Failure to follow instructions may result in injury or product damage.

- 01. Use the unit within the rated specifications.**
Failure to follow this instruction may result in fire or product damage.
- 02. Use a dry cloth to clean the unit, and do not use water or organic solvent.**
Failure to follow this instruction may result in fire or electric shock.
- 03. Keep the product away from metal chip, dust, and wire residue which flow into the unit.**
Failure to follow this instruction may result in fire or product damage.
- 04. Since leakage current still flows right after turning off the power or in the output OFF status, do not touch the load terminal.**
Failure to follow this instruction may result in electric shock.
- 05. Since leakage current still flows right after turning off the power or in the output OFF status, do not touch the load terminal.**
Failure to follow this instruction may result in burn due to high temperature of the surface.

Cautions during Use

- Follow instructions in 'Cautions during Use'. Otherwise, it may cause unexpected accidents.
- Use the product, after 3 sec of supplying power.
- Before use, set the mode and function according to the specification. Since changing the mode / parameter during operation may result in malfunction, set the mode and function after disconnecting load output.
- Re-supply the power to the unit after 3 sec of turning off the power. Failure to follow this instruction may result in malfunction.
- To ensure the reliability of the product, install the product on the panel or metal surface vertically to the ground.
- Install the unit in the well ventilated place.
- While supplying power to the load or right after turning off the power of the load, do not touch the body and heat sink. Failure to follow this instruction may result in a burn due to the high temperature.
- Install a power switch or circuit breaker in the easily accessible place for supplying or disconnecting the power.
- Do not wire to terminals which are not used.
- Use twisted pair wire for communication line.
- Do not use near the equipment which generates strong magnetic force or high frequency noise.

- Since inter element can be damaged when using with coil load, inductive load, etc., the inrush current must be under the rated load current.
- To prevent product malfunction due to noise, wire power, control input, communication, and load cables separately.
- For stable operation, use shield wire for control, alarm, and communication wires. Use a ferrite core on the shield wire to cope with EMC.
- This unit may be used in the following environments.
 - Indoors (in the environment condition rated in 'Specifications')
 - Altitude max. 2,000 m
 - Pollution degree 2
 - Installation category III

Ordering Information

This is only for reference, the actual product does not support all combinations. For selecting the specified model, follow the Autonics website.

DPU ① ② ③ - ④ ⑤ - ⑥

① Control phase

- 1: Single-phase
- 3: 3-phase

② Power supply

- 1: 110 VAC
- 2: 220 VAC
- 3: 380 VAC
- 4: 440 VAC
- 5: 480 VAC

③ Size (rated current capacity)

	DPU1	DPU3
A	0 to 70 A	0 to 50 A
B	80 to 200 A	70 to 200 A
C	250 to 350 A	
D	400 to 600 A	

④ Rated current capacity

Number: Rated current capacity (unit: A)

⑤ Option

- R: RS485 communication
- D: Remote display
- A: Remote display + RS485 communication
- N: None

⑥ [3-phase control model]

Control (FAN) power

- No mark: 220 VAC
- A: 115 VAC

Product Components

- Product
- Instruction manual
- Bolt × 4
- Terminal × 1

Software

Download the installation file and the manuals from the Autonics website.

■ DAQMaster

It is the comprehensive device management program for Autonics' products, providing parameter setting, monitoring and data management.

Manual

For proper use of the product, refer to the manuals and be sure to follow the safety considerations in the manuals.

Download the manuals from the Autonics website.

Display

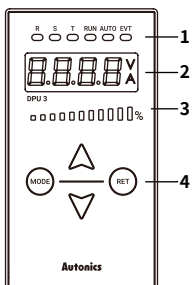

1. Indicator

Indicator	Color	Descriptions
R / S / T	Green	[DPU3 model] Turns ON by display value of display part (E.g.) R, S ON → R-S line voltage display
RUN	Green	Turns ON for RUN, turns OFF of STOP
AUTO	Green	Turns ON for AUTO, turns OFF of MANUAL
EVT	Red	Turns ON for Digital input ON, flashes for alarm output ON

2. Display part (red)

- RUN mode: Displays depending the front display setting
- Setting mode: Displays parameter and setting value
- Unit indicator

Indicator	Descriptions
V	Turns ON for voltage display
A	Turns ON for current display
V + A	Turns ON for power display, turns OFF for resistance and input value display

3. Output BAR (green)

Turns on the current output (voltage / current / power) in a ratio of 0 to 100 % relative to the input.

4. Setting keys

Key	Descriptions
[MODE]	To enter monitoring / operation setting 1, 2 mode and to move between parameters
[▲ / ▼]	To move setting modes and to set parameters.
[RET]	To return to RUN mode from monitoring / operation setting 1, 2 / alarm setting mode

Unit Descriptions

- Configurations may vary by model depending on supported specifications.

■ DPU1 Series

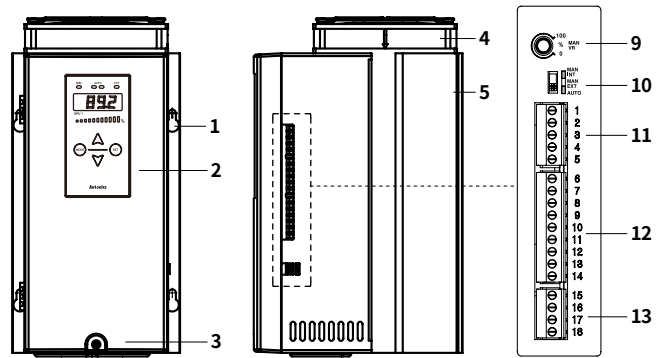

[180° rotated image]

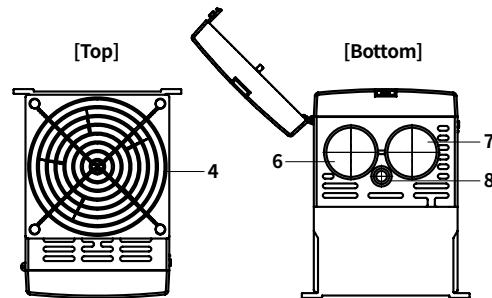

■ DPU3 Series

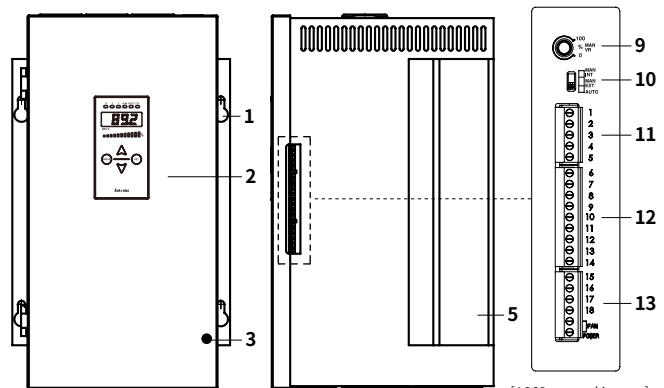

[180° rotated image]

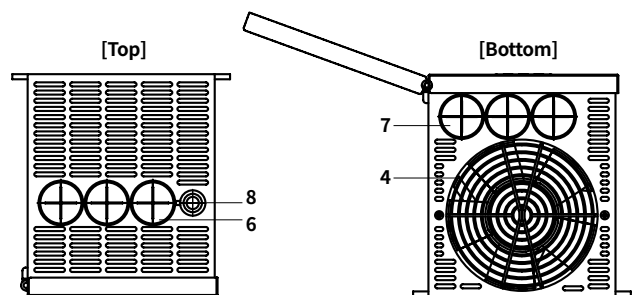

1. Mounting holes

2. Display

3. Case screw

4. Cooling fan ⁽⁰¹⁾

5. Heatsink

6. Load wiring input hole

7. Load wiring output hole

8. Ground wiring hole

9. Internal adjuster

10. AUTO / MANUAL select switch

11. Control input (voltage / current) connector

12. Control input (contact) /

RS485 communication connector

13. DPU1: alarm output connector

DPU3: control power (FAN) /

alarm output connector

(01) DPU1 Series 25 / 40 / 50 A models do not have attached a Fan.

Specifications

Series	DPU1	DPU3
Control phase	Single-phase	3-phase
Rated frequency	50 / 60 Hz (auto recognition), allowable frequency range: ± 2 Hz	
Display method	4 digit 7 segment, Output BAR	
Indicators	Operation / manual control indicator (green) DI, alarm / unit (V, A) indicator (red)	R, S, T indicator (green) Operation / manual control indicator (green) DI, alarm / unit (V, A) indicator (red)
Auto control input	<ul style="list-style-type: none"> Current⁰¹⁾: 4 - 20 mA, 0 - 20 mA Voltage⁰²⁾: 0 - 5 VDC\equiv, 1 - 5 VDC\equiv, 0 - 10 VDC\equiv Contact (non-voltage): ON / OFF Contact (voltage): 0 / 12 VDC\equiv (24 VDC\equiv) Communication: RS485 	
Manual control input	Internal adjuster (10 k Ω), external adjuster (3 to 10 k Ω , ≥ 2 W)	
Digital input (DI)	AUTO / MAN selectable, RUN / STOP selectable, RESET, HOLD, Setting Point 1 to 6	
Display content	Control input, load voltage, load current, load power, load resistance, power supply frequency	
Min. display output	Min. 2.5 % of rated voltage / current	
Certification	CE, RoHS	CE, RoHS, REACH
SCCR Rating	80 kA (UL certification)	

01) Input impedance = 100 Ω

02) Input impedance = 25 k Ω

03) Except DPU35□□□□ / DPU3□□□□□□□□□□ models

Control method	Phase control	Cycle control	ON / OFF control
Control mode	Normal / constant current feedback / constant voltage feedback / constant power feedback	Fixed cycle / variable cycle ⁰¹⁾	-
Applied load	Resistance / inductive load	Resistance load	Resistance load
Output range	0 to 98 %	0 to 100 %	0 to 100 %
Output accuracy of phase control	<ul style="list-style-type: none"> Normal : Within ± 10 % F.S. of rated load voltage Constant current feedback: Within ± 3 % F.S. of rated load current (within variable 1 to 10 times of rated resistance) Constant voltage feedback: Within ± 3 % F.S. of rated load voltage (within variable ± 10 % F.S. of rated voltage) Constant power feedback: Within ± 3 % F.S. of rated load power (within variable ± 10 % F.S. of rated power and within variable 1 to 10 times of rated resistance) 		

01) DPU1 only

Series	DPU1	DPU3
Power supply	110 / 220 / 380 / 440 VAC \sim model	110 / 220 / 380 / 440 / 480 VAC \sim model
Allowable voltage range	90 to 110 % of power supply	85 to 115 % of power supply
Min. load current	1 A	
Control power supply	Included in power supply	115 / 220 VAC \sim model 50 / 60 Hz
Power consumption	≤ 40 W (control power, include FAN)	≤ 60 W (control power, include FAN)
Insulation resistance	≥ 200 M Ω (500 VDC \equiv megger)	
Dielectric strength	Between the charging part and the case: 3,000 VAC \sim 50 / 60 Hz for 1 min	
Vibration	0.75 mm double amplitude at frequency of 5 to 55 Hz in each X, Y, Z direction for 2 hours	
Noise immunity	± 2 kV square wave noise (pulse width: 1 μ s) by the noise simulator	
Ambient temp.	-10 to 50 $^{\circ}$ C, storage: -20 to 80 $^{\circ}$ C (no freezing or condensation)	
Ambient humidity	5 to 90 %RH, storage: 5 to 90 %RH (no freezing or condensation)	

Unit weight (packaged)	DPU1	DPU3
A	≈ 3.0 kg (≈ 3.2 kg)	≈ 6.5 kg (≈ 7.6 kg)
B	≈ 3.0 kg (≈ 5.6 kg)	≈ 11.5 kg (≈ 13.0 kg)
C	≈ 11.0 kg (≈ 12.1 kg)	≈ 20.0 kg (≈ 21.1 kg)
D	≈ 11.0 kg (≈ 19.3 kg)	≈ 30.8 kg (≈ 35.7 kg)

Communication Interface

■ RS485

Comm. protocol	Modbus RTU
Application standard	Compliance with EIA RS485
Max. connection	31-unit (address: 01 to 64)
Comm. synchronous method	Asynchronous
Comm. method	2-wire half duplex
Comm. distance	≤ 800 m
Comm. speed	4,800 / 9,600 / 19,200 / 38,400 (default) bps
Comm. response time	5 to 99 ms
Data bit	8-bit (fixed)
Parity bit	Even (fixed)
Stop bit	1-bit (fixed)

Initial Display When Power is ON

- When power is supplied, after all display will flash for 1 sec, device version > rated voltage > rated current are displayed sequentially. After this, enter into RUN mode.
- Example of DPU□2A-050□ model,

	1. Display part	2. Device version	3. Rated voltage	4. Rated current	5. RUN mode
DPU1	00.00	dP20	220	50	100.3
DPU3	00.00	dP30	220	50	100.3

Alarm

- Parameter setting is available to set alarm delay time, alarm channel, etc.
- For details on parameter setting, refer to the product manual.

Alarm	Display	Operation	Alarm release ⁰¹⁾
Overcurrent	o - E	Stop (SCR OFF)	<ul style="list-style-type: none"> Re-supply power. Press [RET].⁰²⁾ Switch to STOP mode
Overvoltage	o - u	Stop (SCR OFF)	
Fuse break ⁰³⁾	F U S E	<ul style="list-style-type: none"> DPU1: Stop (SCR OFF) DPU3: when 1-phase break, it maintains output when 2-phase break, it stops output. 	
Heatsink over heat	E E n P	Stop (SCR OFF)	
SCR error ⁰³⁾	S C r	Stop (SCR OFF)	Automatically released within the setting range
Heater break	H - b E	Continues operation	
Phase loss ⁰⁴⁾	P L	Stop (SCR OFF)	<ul style="list-style-type: none"> Re-supply load input power. Re-supply power.

01) If the alarm occurrence condition is not removed, the alarm is re-occur even if the alarm release method is applied.

02) The power is reapplied.

03) If the alarm is not released after power is applied again, replace the fuse or check whether the SCR element is abnormal.

04) DPU3 only

Replacement of Fuse

- To prevent accident, replace a fuse every two years.
- Must turn off the power before removing the fuse.
- If using a fuse not supplied by Autonics, the performance of the product is not guaranteed. When replacing the fuse, use a fuse of the recommended specification.

■ Fuse position

- After loosening the case screws, there is a fuse on the side of the product.

[DPU1]

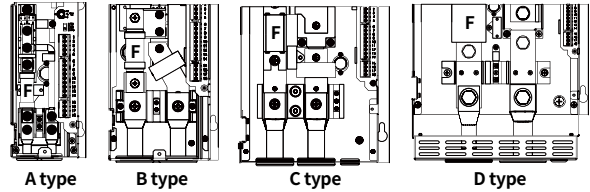

[DPU3]

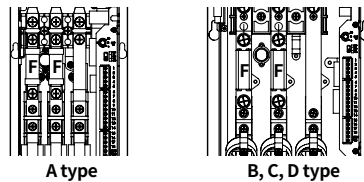

- Among R, S, T inputs, R and S have a built-in fuse, but T does not have an internal fuse. If a fuse is required, install a fuse of the following or equivalent performance outside the product separately.

Device size	Fuse fixed bolt	
	DPU1	DPU3
A	M5	M6
B	M8	
C	M8	
D	M12	

■ Fuse recommended specifications

- Rated short circuit test is evaluated as a recommended fuse.

Rated load current [A]	DPU1		DPU3	
	Rec. fuse	Manufacturer	Rec. fuse	Manufacturer
25	50FE	BUSSMANN	50FE	BUSSMANN
40	63ET		63ET	
50	80ET		80ET	
70	100FE		170M1367	
80	660GH-125	HINODE	170M1368	
100	660GH-160		170M1369	
120	660GH-160		170M1369	
150	660GH-200		170M1370	
180	660GH-250		170M1370	
200	660GH-250		170M1372	
250	170M2620	BUSSMANN	170M2620	
350	170M2621		170M2621	
400	A60X500-4(TA)	MERSEN	170M3471	
500	A60X600-4(TA)		170M4466	
600	A60X600-4(TA)		170M4466	

Connections

- Terminal configuration by model may differ depending on the supported spec.

■ DPU1 Series

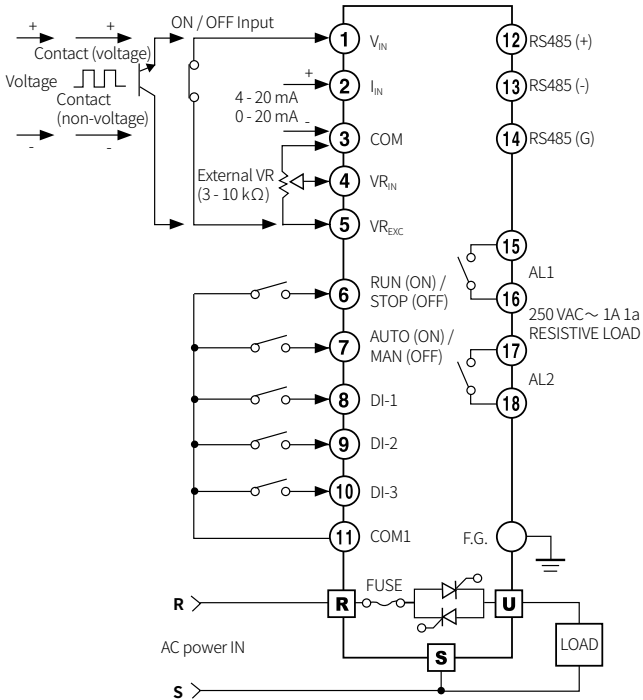

■ DPU3 Series

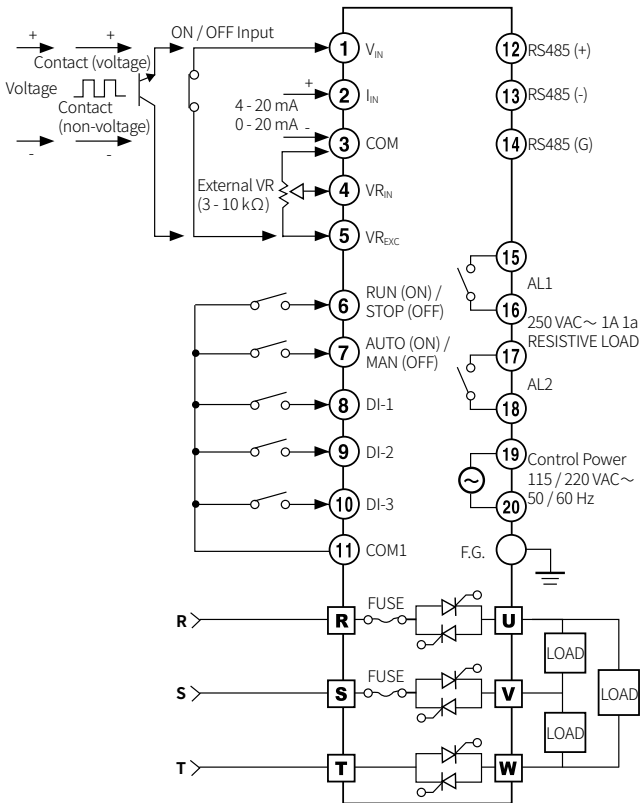

■ Suitable specification

- The following connectors can be used with equivalent or substitute.

Connector type	Connector configuration		Manufacturer
	DPU1	DPU3	
Control input (current, voltage)	TS 05 515B	TS 05 515B	ANYTEK
Alarm output / control power (DPU3)	TS 04 515B	TS 06 515B	
Control input (contact) / RS485 communication	TS 09 515B	TS 09 515B	

Cautions during Wiring

- DI input switch: For low current, ON resistance: 20Ω or less (including wiring resistance).
- Do not arbitrarily replace the display - main body connector of the remote display model.
- For crimp terminals of load input/output connectors, use the following UL approved terminals. Be sure to use crimp terminals with an insulating sleeve (tube).

Device size	DPU1/3 wire thickness	Crimp terminal spec.	Bolt tightening torque
A	≥ 25 mm ²	25-S6 (1)	5.6 to 6.0 Nm
B	≥ 95 mm ²	95-8 (1)	13.6 to 14.5 Nm
C	≥ 2 × 70 mm ²	70-8 (2)	13.6 to 14.5 Nm
D	≥ 2 × 185 mm ²	185-12 (2)	47.0 to 50.0 Nm

Cautions during Installation

High Temperature Caution
While supplying power to the load or right after turning off the power of the load, do not touch the body and heatsink. Failure to follow this instruction may result in a burn due to the high temperature.

■ Mount space

- When installing multiple power controllers, keep space between power controllers for heat radiation. Horizontal: ≥ 80 mm, vertical: ≥ 100 mm

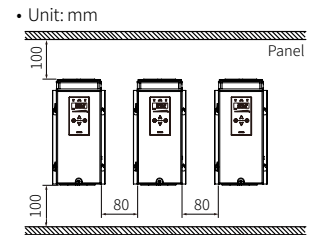

Dimensions

- Unit: mm, For the detailed drawings, follow the Autonics website.

■ DPU1 Series

- The figure is based on the B size.

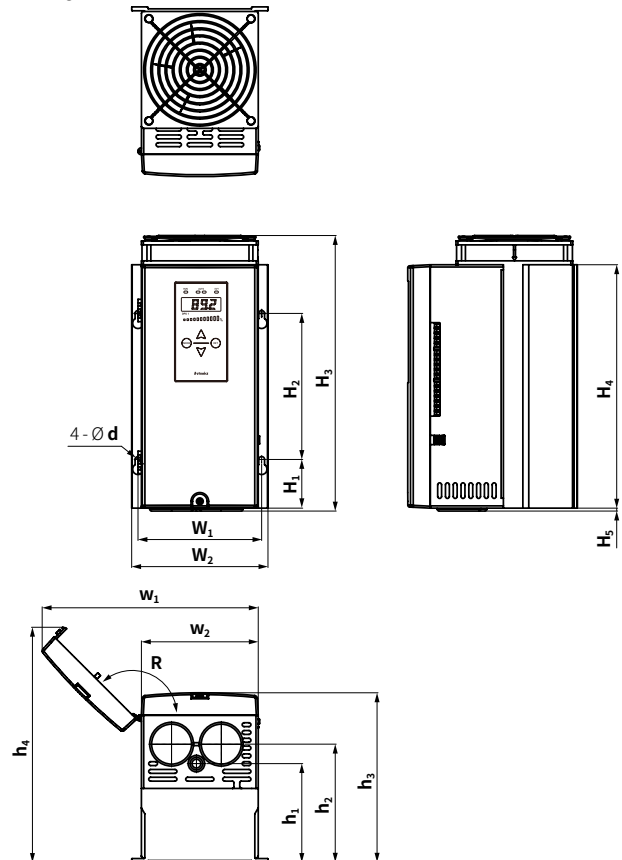

Size	d	R	W ₁	W ₂	H ₁	H ₂	H ₃	H ₄	H ₅	w ₁	w ₂	h ₁	h ₂	h ₃	h ₄
A	6	135°	82	97	40	150	233 ^{0U1}	230	3	154	80	90	110	170.3	209.5
B	6	135°	127	140	50	150	283	250	3	222	120	101.5	121.5	174	241.5
C	7	160°	193	213	50	200	342	300	4	368	185.6	131	132	179	244
D	7	160°	261	278	40	200	422	380	4	497	252.7	138	156	212	296

01) Rated current capacity 70 A model: 263

■ DPU3 Series

• The figure is based on the C size.

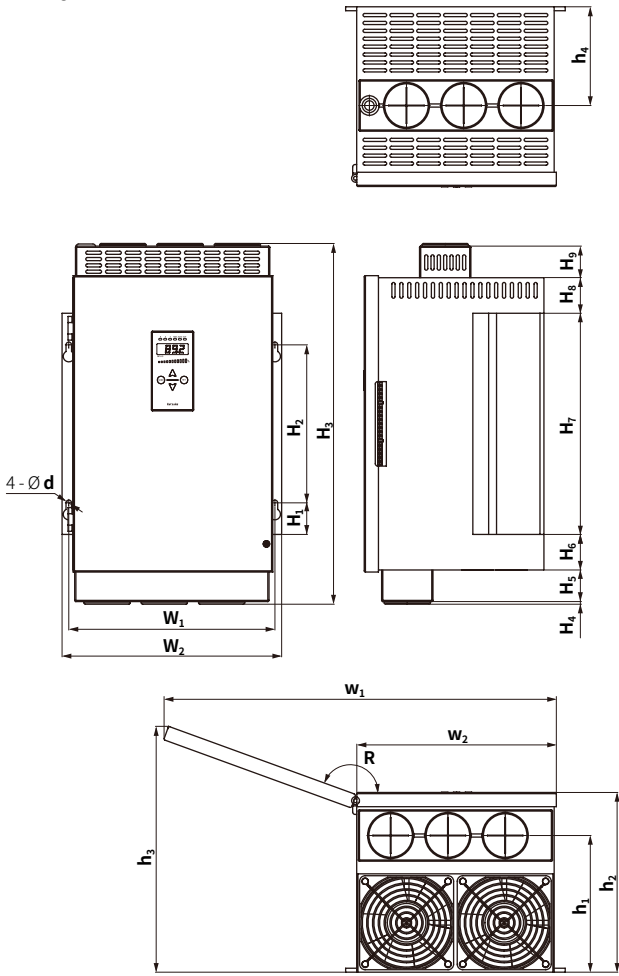

Size	d	W ₁	W ₂	H ₁	H ₂	H ₃	H ₄	H ₅	H ₆	H ₇	H ₈	H ₉
A	6	127	140	63.5	150	309	H ₄ + H ₅ = 29	-	40	280	40	-
B	7	195	213	40	200	367	3.5	-	40	280	40	-
C	7	261	278	40	200	457	3.3	40	45	280	45	40
D	8.5	405	427	66.5	330	536	4	32.5	H ₆ + H ₇ + H ₈ + H ₉ = 495.5	-	-	-

Size	R	w ₁	w ₂	h ₁	h ₂	h ₃	h ₄
A	160°	244	122.6	138	200	239	116
B	160°	366	185.6	176	217	278	126
C	160°	497	252.6	173	227.5	311	125
D	160°	755	385.6	204.5	275.5	405	204.5

■ Remote display

• Unit

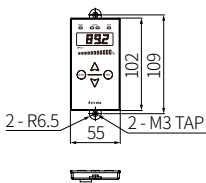

• Plate

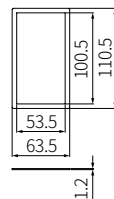

• Panel cut-out

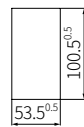

Mode Setting

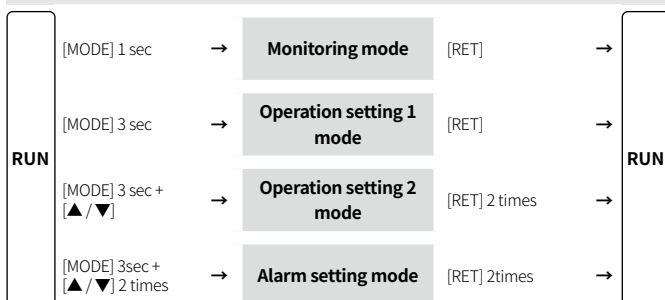

Parameter Setting

- Some parameters are activated / deactivated depending on the model or setting of other parameters. Refer to the description of each parameter.
- Do not change parameters during output.
- If any key is not entered for 30 sec in each parameter, it returns to RUN mode.
- [▲], [▼] key: Displays SV for each parameter.
Changes setting value for number SV.
- [MODE] key: Enter each setting mode.
Saves the SV of the current parameter and moves to the next parameter.
Changes SV.
Moves digit for number SV.

■ [DPU1] Monitoring mode

Parameter	Display	Display range
M1-1	Input value	$i \ n$ 0.0 to 100.0 % For ON / OFF or SSR pulse input, it displays 0 or 100.
M1-2	Load voltage	$L \ d - u$ 0 to rated voltage range, V
M1-3	Load current	$L \ d - R$ 0 to rated current range, A
M1-4	Load power	$P \ u$ 0 to rated power range, kW
M1-5	Load resistance	$r \ E \ S$ 0 to 100 % Displays the present resistance as percentage compared to the set resistance of full load auto recognition.
M1-6	Power frequency	$F \ r \ E \ 9$ 45.0 to 65.0 Hz

■ [DPU3] Monitoring mode

Parameter	Display	Display range
M2-1	Input value	$i \ n$ 0.0 to 100.0 %
M2-2	Voltage between U-V line	$U - u$
M2-3	Voltage between V-W line	$u - v$ 0 to rated voltage range, V
M2-4	Voltage between W-U line	$v - U$
M2-5	U-phase load current	$L \ R - U$
M2-6	V-phase load current	$L \ R - u$ 0 to rated current range, A
M2-7	W-phase load current	$L \ R - v$
M2-8	Load power	$P \ u$ 0 to rated power range, kW
M2-9	Load resistance	$r \ E \ S$ LLLL, 0 to 100 %, HHHH Displays the present resistance as percentage compared to the set resistance of full load auto recognition.
M2-10	Power frequency	$F \ r \ E \ 9$ 45.0 to 65.0 Hz

■ Operation setting 1 mode (OP)

Parameter	Display	Default	Setting range	Apply condition	
O1-1	Soft start time	$S \ t - t$	0000	0 to 100 sec	-
O1-2	Start limit	$S - L \ n$	1 100	0 to 110 %	-
O1-3	Start limit time	$S - L \ t$	0000	0 to 100 sec	-
O1-4	Output slope manual adjustment	$R - G \ R$	o F F	ON, OFF	-
O1-5	Output slope	$S \ L \ o \ P$	1000	0.00 to 1.00 %	O1-4 Output slope manual adjustment: OFF
O1-6	BASE UP	$b - U \ P$	0000	0 to 100 %	-
O1-7	Soft up time	$U \ P - t$	0000	0 to 999 sec	O2-2 Control method: V-FB, C-FB, W-FB
O1-8	Soft down time	$d \ n - t$	0000	0 to 999 sec	-
O1-9	Output low-limit value	$L - o \ L$	0000	0 to 110 %	-
O1-10	Output high-limit value	$H - o \ L$	1 100	0 to 110 %	-
O1-11	Current limit	$C - L \ n$	1 100	0 to 110 %	-
O1-12	Setting Point 1	$S \ P \ 1$	0000	0 to 100 %	O2-3 to 5 DI-1 to 3 function: SPM, SP1, SP2, SP3
O1-13	Setting Point 2	$S \ P \ 2$	0000		
O1-14	Setting Point 3	$S \ P \ 3$	0000		
O1-15	Setting Point 4	$S \ P \ 4$	0000		
O1-16	Setting Point 5	$S \ P \ 5$	0000	0 to 100 %	O2-3 DI-1 function: SPM
O1-17	Setting Point 6	$S \ P \ 6$	0000		
O1-18	Proportional constant ⁽¹⁾	P	0 150	1 (0 %) to 2000 (100 %)	O2-2 Control method: PA, V-FB, C-FB, W-FB
O1-19	Integral constant ⁽¹⁾	I	0 200	0.1 to 999.9 sec	

(1) It compensates error from the target value. And the optimal values of proportional constant and integral constant are set as factory defaults. If proportional constant, integral constant value is small, response is fast and it may cause overshoot or hunting. If proportional constant, integral constant value is big, response is slow.

■ Operation setting 2 mode (ST-1)

Parameter	Display	Default	Setting range	Apply condition
O2-1	Control input type	$i n - P$	$4 - 2 \emptyset$ 4-20: 4 - 20 mA 0-20: 0 - 20 mA 1-5: 1 - 5 VDC= 0-5: 0 - 5 VDC= 0-10: 0 - 10 VDC= SSR: SSR contact (voltage / non-voltage) COM: RS485 communication	-
O2-2	Control method	$C - \bar{n} d$	$P \bar{R}$ [DPU1 model] PA: Phase control V-FB: Constant voltage feedback C-FB: Constant current feedback W-FB: Constant power feedback F-CY: Fixed cycle control V-CY: Variable cycle control ONOF: ON / OFF control [DPU3 model] PA: Phase control V-FB: Constant voltage feedback C-FB: Constant current feedback W-FB: Constant power feedback F-CY: Fixed cycle control ONOF: ON / OFF control	-
O2-3	DI-1 function	$d i - 1$	$5 P \bar{n}$ SPM: Multi setting point SP1, SP2, SP3: Single setting point RST: Turn digital input ON and OFF, this unit resets and re-starts. HOLD: It operates hold the output and display value when digital input maintains ON status.	-
O2-4	DI-2 function	$d i - 2$	$5 P 1$ SP1, SP2, SP3, RST, HOLD	O2-3 DI-1 function: except SPM
O2-5	DI-3 function	$d i - 3$	$5 P 1$ SP1, SP2, SP3, RST, HOLD	
O2-6	Input correction	$i n - b$	$\emptyset \emptyset \emptyset \emptyset$ -99.9 to 99.9	-
O2-7	Input slope correction	$S P \bar{R} n$	$\emptyset \emptyset \emptyset \emptyset$ -99.9 to 99.9	-
O2-8	Display value content	$d i 5 P$	$L d - u$ [DPU1 model] LD-V: Load voltage AMP: Load current KW: Load power REF: Control input $U - u$ [DPU3 model] U-V: U-V line load voltage V-W: V-W line load voltage W-U: W-U line load voltage LA-U: U-phase load current LA-V: V-phase load current LA-W: W-phase load current KW: Load power REF: Control input	-
O2-9	BAR content	$b \bar{R} r$	$L d - u$ [DPU1 model] Same as setting range of O2-8 display value content $U - u$ [DPU3 model] Same as setting range of O2-8 display value content	-
O2-10	Load resistance display method	$d r E 5$	$d o \bar{U} n$ DOWN: Decrease rate of number of loads UP: Increase rate of load resistance	-
O2-11	Full load auto recognition	$F - L d$	$\emptyset F F$ OFF ON ⁽¹⁾ : 100 % output for about 3 sec	-
O2-12	Com. address	$R d d r$	$\emptyset \emptyset \emptyset 1$ [RS485 communication model] 1 to 99	-
O2-13	Com. speed	$b \bar{R} U d$	$\bar{3} \bar{B} 4$ [RS485 communication model] 48: 4,800 bps 96: 9,600 bps 192: 19,200 bps 384: 38,400 bps	-
O2-14	Com. write	$C o \bar{n} \bar{U}$	$E n \bar{R}$ [RS485 communication model] ENA: Enable DISA: Disable	-
O2-15	Parameter lock ⁽²⁾	$L o C \bar{L}$	$\emptyset F F$ OFF: Unlock LOC1, LOC2, LOC3	-

- 01) If you press the [MODE] key after selecting ON, 100 % is output immediately, so be careful when setting. When using special load using low voltage and high current such as (super) tantalum, SiC, molybdenum, tungsten, etc, it may cause heater break alarm. This alarm does not have problem in operation but it occurs when it does not detect the load when using as low voltage. Set the below notes to clear the alarm.
1. O2-10 Load resistance display method = UP
2. S1-10 Heater break alarm value = 500

Setting range	Operation setting 1 mode (OP)		Operation setting 2 mode (ST-1)		Alarm setting mode (ST-2)	
	Check	Set	Check	Set	Check	Set
OFF	O	O	O	O	O	O
LOC1	O	O	O	X	O	O
LOC2	O	O	X	X	O	X
LOC3	O	X	X	X	O	X

When set to LOC1, LOC2, LOC3, O2-15 Parameter lock can be checked and set.

■ Alarm setting mode (ST-2)

Parameter	Display	Default	Setting range
S1-1	Overcurrent alarm value	$\emptyset C - u$	$1 1 \emptyset \emptyset$ 0 to 120 %
S1-2	Overcurrent delay time	$\emptyset C - t$	$\emptyset \emptyset \emptyset 5$ 0 to 100 sec
S1-3	Overcurrent alarm CH	$\emptyset C - \bar{R}$	$\bar{R} L 1$ NON, AL1, AL2
S1-4	Overvoltage alarm value	$\emptyset u - u$	$1 1 \emptyset \emptyset$ [DPU1 model] 0 to 120 % [DPU3 model] 0 to 300 %
S1-5	Overvoltage delay time	$\emptyset u - t$	$\emptyset \emptyset \emptyset 5$ 0 to 100 sec
S1-6	Overvoltage alarm CH	$\emptyset u - \bar{R}$	$\bar{R} L 1$ NON, AL1, AL2
S1-7	Fuse break alarm CH	$F U S E$	$\bar{R} L 1$ NON, AL1, AL2
S1-8	Heat sink overheating alarm CH	$H E \bar{R} t$	$\bar{R} L 1$ NON, AL1, AL2
S1-9	SCR error alarm CH	$S C r$	$\bar{R} L 1$ NON, AL1, AL2
S1-10	Heater break alarm value	$H b - u$	$\emptyset 1 \emptyset \emptyset$ 10 to 500 %
S1-11	Heater break alarm CH	$H b - \bar{R}$	$\bar{R} L 2$ NON, AL1, AL2
S1-12	Heater break alarm delay time	$H b - t$	$\bar{3} \emptyset$ [DPU1 model] 0, 1, 2, 3, 5, 10, 20, 30 sec
S1-13	Phase loss alarm CH	$P L - \bar{R}$	$n \emptyset n$ [DPU3 model] NON, AL1, AL2

Alarm

By setting parameters, you can set alarm delay time and alarm CH, etc. During alarm operation, EVT indicator flashes every 0.5 sec. When each alarm channel set as NON, EVT indicator does not flash even though alarm occurs.

■ Overcurrent alarm

It can protect the load / fuse from overcurrent. During alarm operation, O-C on display part flashes every 0.5 sec and the output stops (SCR OFF). When S1-3 Overcurrent alarm CH set as [NON], alarm output does not occur but [O-C] flashes.

- Operation condition
: If the current higher than the OC-V set value of S1-1 Overcurrent alarm value is applied during the OC-T set time of the S1-2 Overcurrent delay time, an alarm occurs.

■ Overvoltage alarm

It can protect the load from overvoltage. During alarm operation, O-V on display part flashes every 0.5 sec and the output stops (SCR OFF).

- Operation condition
: If the voltage higher than the OV-V set value of S1-4 Overvoltage alarm value is applied during the OV-T set time of the S1-5 Overvoltage delay time, an alarm occurs.

■ Fuse break alarm

During alarm operation, FUSE on display part flashes every 0.5 sec. For DPU1 model, output stops (SCR OFF). For DPU3 model, when single-phase break, it maintains output and when 2-phase break, it stops output (SCR OFF).

- Operation condition: If the fuse break, an alarm occurs.

■ Heatsink over heat alarm

During alarm operation, TEMP on display part flashes every 0.5 sec and the output stops (SCR OFF).

- Operation condition: If the temperature of the heatsink maintains above 75 °C, an alarm occurs.

■ SCR error alarm

During alarm operation, SCR on display part flashes every 0.5 sec and the output stops (SCR OFF).

- Operation condition
: Even though output is 0 %, if the current of 10 % or more of the rated load current flows for over 3 sec (or over 5 cycle) continuously, SCR error alarm occurs.

■ Heater break alarm

During alarm operation, H-BK on display part flashes every 2 sec and the output maintains.

- Operation condition
: When O2-10 Load resistance display method set as UP, alarm occurs if it is over S1-10 Heater break alarm value during S1-12 Heater break alarm delay time.
When O2-10 Load resistance display method set as DOWN, alarm occurs if it is below S1-10 Heater break alarm value during S1-12 Heater break alarm delay time.
- S1-12 Heater break alarm value can be set only for DPU1 model.
Setting range: 0, 1, 2, 3, 5, 10, 20, 30 sec
- Regardless of control method (phase control, cycle control), it operates. For the operation, over 10 % of control output (phase control, cycle control) and over 30 % of rated current are required.
- Hysteresis is fixed as 1 % for ON / OFF interval.
E.g.) When SV for heater disconnect alarm is 50 %,

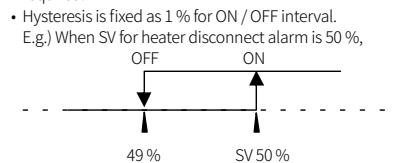

■ Phase loss alarm

During alarm operation, PL on display part flashes every 0.5 sec and the output stops (SCR OFF).

- Operation condition
: If the load input power is not applied, an alarm occurs.
: If the load input power is applied normally but an internal frequency abnormality occurs and the display's R indicator (green) turns off, an alarm occurs.
- Only for DPU3 models.

Control Method

Phase control

Phase control method is to control output by dividing AC phase by control input signal.

Normal = Phase equal division method by control input

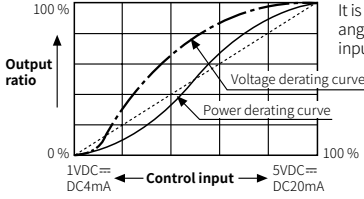

It is general output method to divide control angle proportionally according to control input signal and to output it.

Constant voltage feedback control mode

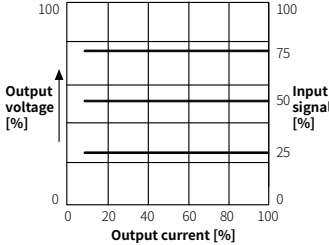

It outputs a constant voltage proportional to the control input so that the output voltage does not fluctuate against fluctuations in power voltage and load resistance fluctuations of loads (iron, chromium, nichrome, etc.) with a small electrical resistance temperature coefficient.

Constant current feedback control mode

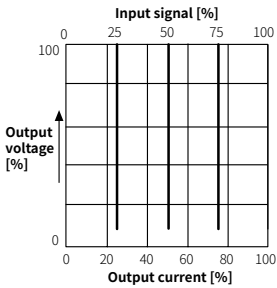

It outputs a constant current proportional to the control input so that the output current does not fluctuate against fluctuations in power voltage and load resistance fluctuations of loads (platinum, molybdenum, tungsten, etc.) in which the temperature coefficient of electrical resistance varies significantly from 6 to 12 times the normal temperature.

Constant power feedback control mode

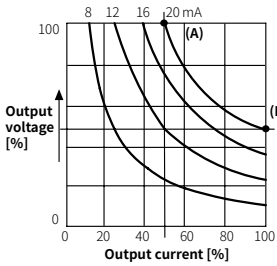

It is proper control method for a heater which resistance value variation by silicon carbide (SiC) heating is big. It outputs constant power which is proportion to control input even though load variation and power supply variation.
 (A): [output voltage 100% × output current 50%]
 (B): [output voltage 50% × output current 100%]
 • Output characteristics is proper 50% of the curve which connects the point (A) and the point (B). The current output capacity of this unit should be over two times of load capacity.

Cycle control, zero cross turn-on

Compared to the phase control method, the load control linearity is better.

Since it is always ON or OFF at the zero point of AC, no noise is generated during ON / OFF, so it is a suitable control method for an environment where noise is not affected or an electric furnace with a large heat capacity.

Fixed cycle control mode

During fixed cycle (60 cycles fixed) of load power, it repeats ON / OFF cycle as constant ratio according to control input signal and controls the power supplies on the load.

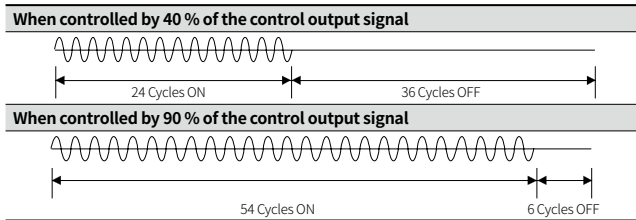

Variable cycle control mode

By optimizing the number of cycles of the load power, it controls the power applied to the load by operating ON / OFF at a ratio proportional to the control input signal.

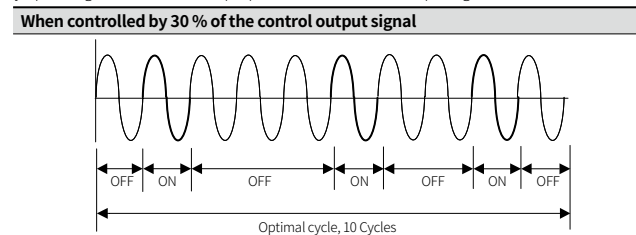

ON / OFF control, zero cross turn-on

This is control method that output is 100% at control input ON, and 0% at control input OFF. It is the same function as SSR (Solid State Relay). It always turns ON or OFF at zero point of AC.

When using ON / OFF control method, output control, SOFT START, SOFT UP / DOWN, input correction, and input slope correction functions are not applied.

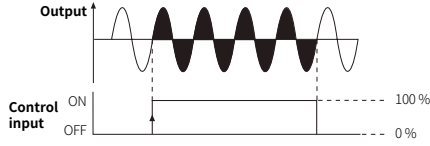

Function

SOFT START

This function protects the load in cases that the set temperature is high, such as controlling the load (platinum, molybdenum, tungsten, infrared lamp, etc.) in which inrush current flows when power is supplied, or showing large width of temperature rise during initial operation.

If changing input before SOFT START function completed, T is increased or decreased as the changed difference (%).

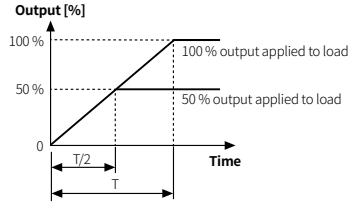

- T: SOFT START set time. Time to get the output which is applied into the load is 100%.
- T/2: Time to get the output which is applied into the load is 50%.

Output slope manual adjustment

This function is to adjust manually (internal or external adjuster) output value ratio for control input.

When setting A-GA set value of O1-4 Output slope manual adjustment as ON in AUTO operation, SLOP (O1-5 Output slope) is not applied. It displays slope value by the internal or external adjuster input.

When setting A-GA set value of O1-4 Output slope manual adjustment as ON, set output slope by the inner 3-level slide switch.

Type	Description
MAN INT	Adjust output slope with the internal adjuster
MAN EXT	Adjust output slope with the external adjuster
AUTO	No function

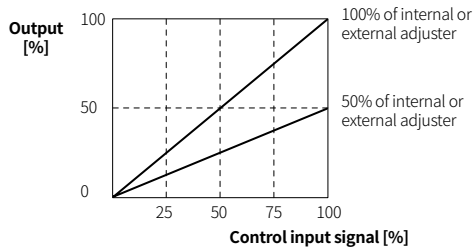

Output slope

This function is to set output changed ratio by control input.

Output value when setting slope: Input × slope value.

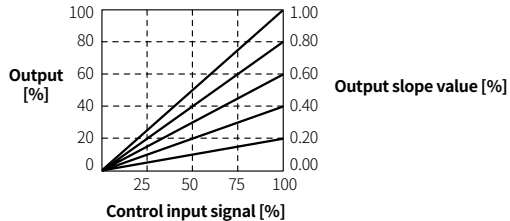

BASE UP

This function is to add set value of O1-6 BASE-UP to input signal.

It is applied only when O1-9 Output low-limit value is 0%.

It is limited by set value of O1-2 Start limit at initial start.

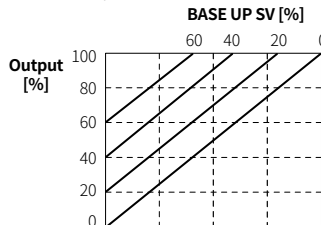

- O1-6 BASE UP SV < O1-10 Output high-limit value
- Output value for BASE UP setting = Input (%) × Slope value + BASE UP SV

SOFT UP / DOWN

Unlike SOFT START which operates only once at supplying power, this function protects load from the inrush current in the RUN mode. When reached to the target output value, operation stops.

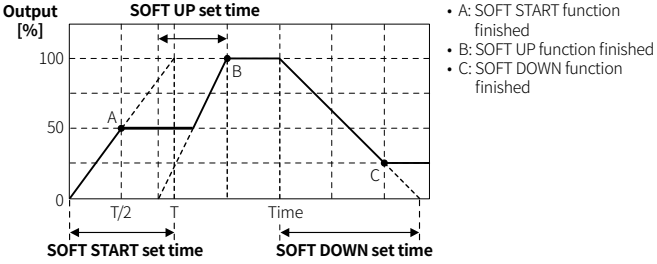

Output high / low-limit value

This function is to limit output range to protect load.

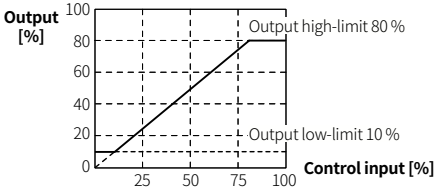

Current limit

This function limits current when using big inrush load to protect SCR element. Especially for voltage feedback, current for load resistance value flows and it may over the rated SCR only voltage control. Therefore, it limits current to prevent over the rated current.

There is one output SCR element in DPU1 model, and three output SCR elements in DPU3 model. It is normal status when the resistance between K and G is 10 to 100 Ω during checking SCR elements. When load indicator turns OFF, short G and open momentarily as test, load indicator turns ON. When the load indicator does not turn ON, SCR elements are bad conditions.

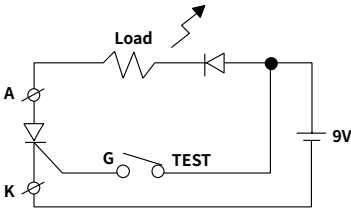

Digital input (DI1 to DI3) setting

When setting ON (close) to DI input, the front EVT indicator turns ON or setting OFF (open), the front EVT indicator turns OFF.

- Multi SP: O2-3 DI-1 function set as SPM, 6 setting points are available to set at O1-12 SP1 to O1-17 SP6 parameters. Depending on digital input, controls output. E.g.) O2-3 DI-1 function = SPM, O1-12 SP1 = 20%, O1-13 SP2 = 40%, O1-14 SP3 = 60%, O1-15 SP4 = 80%, O1-16 SP5 = 100%, O1-17 SP6 = 0%

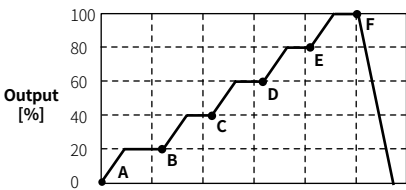

	DI-1	DI-2	DI-3
A	ON	OFF	OFF
B	OFF	ON	OFF
C	ON	ON	OFF
D	OFF	OFF	ON
E	ON	OFF	ON
F	OFF	ON	ON

- Single SP: O2-3 DI-1 function to O2-5 DI-3 function are set as SP1 to SP3, 3 setting points are available to set at O1-12 SP1 to O1-14 SP3 parameters. Single SP function designates SP1, SP2, SP3 by each digital input and make output reach to the dedicated setting point. Individual and duplicate settings are available. E.g.) O2-3 DI-1 function = SP1, O1-12 SP1 = 20%
O2-4 DI-2 function = SP2, O1-13 SP2 = 40%
O2-5 DI-3 function = SP3, O1-14 SP3 = 60%

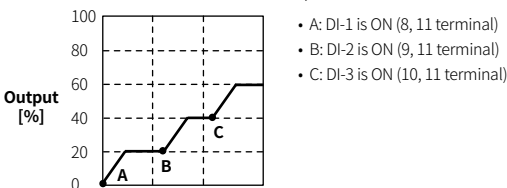

- RESET: After selecting RESET function, turn digital input ON and OFF, this unit resets and re-starts.
- HOLD: After selecting HOLD function and digital input is ON, output and display value of this unit operates hold when digital input maintains ON status.

Input correction

It compensates the offset between actual input value and measured input value. E.g.) When input monitoring value is 5% at 4 mA in DC4 - 20 mA control input, setting O2-6 Input correction = -5.0% calibrates the input monitoring value to 0%.

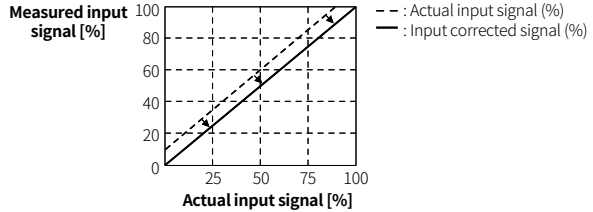

Input slope correction

It protects the load by limiting 100% of power supplied to the load. It compensates the gain of the measured 100% input for actual 100% input value. Calibrated monitoring value =

$$\text{Monitoring value} + \frac{\text{Monitoring value}}{100 - \text{input slope correction value}} \times \text{Input slope correction value}$$

- E.g.) When the input monitoring value is 99% at 20 mA in DC 4 - 20 mA control input, setting O2-7 Input slope correction = 1 calibrates the input monitoring value to 100%.

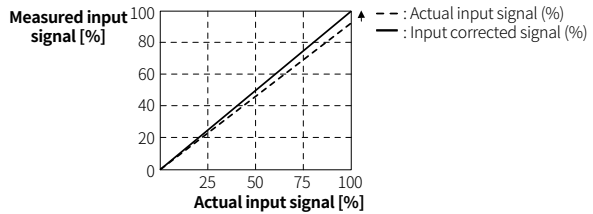

Load resistance display method

This function is for display M1-5 / M2-9 Load resistance into a percentage in monitoring mode when disconnecting the parallel load. You can select this value as increase rate of load resistance [UP] or as decrease rate of number of loads [DOWN].

- Decrease rate of number of loads [DOWN] displays correct decrease rate only when the connected each load resistance is same. E.g.) R1 to R10 = 10 Ω of each and load resistance (R) = 1 Ω, When disconnecting R1 to R5,

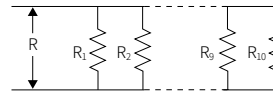

- When selecting 2-10 Load resistance display method = UP, It is based on 100% of R, 1 Ω. When disconnected R1 to R5, load resistance (R) is 2 Ω and M1-5 / M2-9 Load resistance in monitoring mode displays 200%.
- When selecting 2-10 Load resistance display method = DOWN It is based on 100% of 10 loads (R1 to R10). When disconnected R1 to R5, the number of load are 5 (R6 to R10) and M1-5 / M2-9 Load resistance in monitoring mode displays 50%.

Segment Table

The segments displayed on the product indicate the following meanings. It may differ depending on the product.

7 segment				11 segment				12 segment				16 segment			
0	1	2	3	0	1	2	3	0	1	2	3	0	1	2	3
4	5	6	7	4	5	6	7	4	5	6	7	4	5	6	7
8	9	A	B	8	9	A	B	8	9	A	B	8	9	A	B
C	D	E	F	C	D	E	F	C	D	E	F	C	D	E	F
G	H	I	J	G	H	I	J	G	H	I	J	G	H	I	J
K	L	M	N	K	L	M	N	K	L	M	N	K	L	M	N
O	P	Q	R	O	P	Q	R	O	P	Q	R	O	P	Q	R
S	T	U	V	S	T	U	V	S	T	U	V	S	T	U	V
W	X	Y	Z	W	X	Y	Z	W	X	Y	Z	W	X	Y	Z