

MS86W Series User Manual

Thank you for purchasing Menics product.
For the proper and safe use of this product, please read and fully understand this manual before use.

Instructions for safety

※ 'Instruction for safety safety' is made to prevent accidents or risks in advance by using the product safely and correctly and be sure to observe it.

※ Instructions are divided into two categories as "Warning" and "Attention" and they are as follows.

Warning If instruction is violated, there is the possibility of serious injury or death.

Attention If instruction is violated, there is possibility of minor injury or damage on the product.

※ The meaning of the picture symbols used in the product and User manual are as follows.

 is the sign meaning attention needs to be paid because there is the concern of risk occurrence under certain condition.

Warning

1. In case it is used for the machines which make greater impact on life or property (e.g. nuclear power control, medical equipment, railroad car, aerospace, combustion equipment, recreation equipment, etc. or safety devices), make sure to attach safety device bifuriously before use.
There is the possibility of causing huge losses resulted from fire, personal injury and property damage.

2. Do not disassemble and renovate the product. Please contact the head office or regional office for internal inspection or repair.
There is the risk of causing fire, electrical shock and product damage.

3. While power is on, do not make wiring, maintenance or repair.
There is the danger of electrical shock.

4. Rated voltage range must be kept for the power input voltage.
There is the danger of fire or electric shock.

5. Before power on, make sure to check whether connection is made correctly.
There is the danger of fire, electrical shock or product damage.

6. When replacing lens, there might be remaining current.
Make sure to replace lens one minute after putting off power.
There is the danger of electric shock.

7. Do not use the product in the area such as outdoor and explosion hazard, flammable gas, watery area, near to flammable material.
There is the danger of fire, electric shock or injury.

8. When making installation, earthing must be done solely and use grounding wire of AWG No 16 or above.
There is the danger of electric shock.

Attention

1. Do not leave obstacle that hinder the flow of air circulation.
There is the danger of deformation and product damage caused by heat.

2. When the product is in operation, do not touch the product for a while.
There is the danger of burn.

3. In case abnormality happens to the product, unplug the input power connection immediately.
There is the danger of fire or product damage.

4. Do not use in places with severe vibration.
There is the danger of product damage.

5. When cleaning, do not use water, organic solvent and clean with towel with -out moisture.
There is the danger of electric shock or fire.

Steady+ Flashing + Rotation + Buzzer



1. Product model classification

MS86W - R 0 0 - R
① ② ③

1. Function

R	Steady + Flashing + Rotating
B	Steady + Flashing + Rotating + Buzzer (Buzzer operation: 24V only)

2. Power supply

00 | 12 ~ 24VAC/DC

3. Lens color

R	Red	Y	Yellow
B	Blue	C	Clear
G	Green		

2. Part name

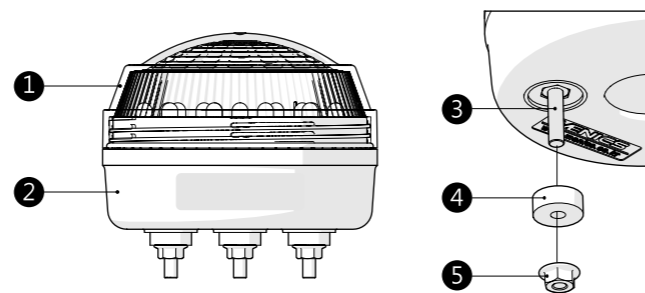

No	Part name	Material
1	Lens cap	PC resin
2	Base Body	ABS resin
3	Fastening screw	SUS M4X20
4	Dustproof rubber	NBR
5	Flange fixing nut	SUS M4

[Buzzer sound hole]

◆ When installing display light with built-in buzzer, make sure to maintain the space (gap) between the installed side and base body at least maximum 5mm or above.

3. Ratings / Performance

Function	Steady, Flashing, Rotating, Buzzer	
Power Supply	12~24VAC/DC	
Dimension	Ø86mm	
Buzzer level	maximum 80±5dB (at 1m)	
Flashing rate	Internal PCB board dip switch	F1: 80 ±10 times flashing per minute F3: 240±10 times flashing per minute (emergency signal light)
Rotating rate	App. 130±20rpm (Clockwise rotation)	
Material	Body-ABS resin, Lens-PC resin	
Ambient Temperature	-15 ~ 40°C	
Storage ambient temperature	-20 ~ 70°C	
Ambient Humidity	45 ~ 85% RH	
Withstand Voltage	500V AC 50/60Hz for 1 minute	
Protection structure	IP65	
Approval	UL, RoHS	Vibration
Wire size	1007UL / 22AWG	0.75mm at 10~55Hz
Weight	App. 170g	

Note: LED lifetime depends on operating condition or environment.

Current consumption (Maximum current consumption when LED is lit.)

	Red	Yellow	Green	Blue	White
General	0.50A	0.50A	0.30A	0.35A	0.38A
Buzzer	0.53A	0.53A	0.34A	0.38A	0.40A

4. Outside dimension (Unit: mm)

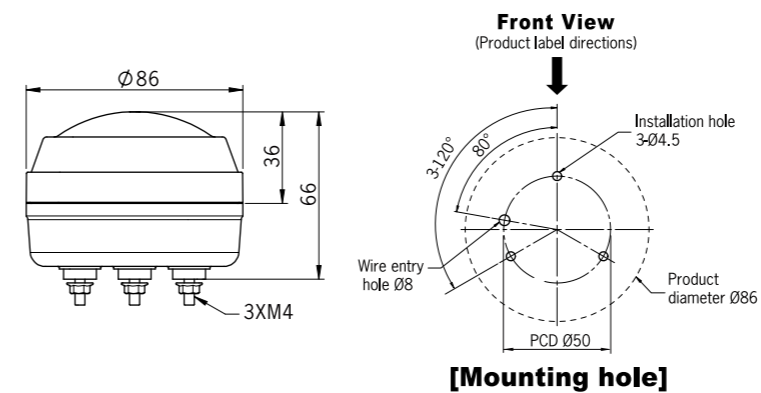

5. Product Installations

- This product has been manufactured with the structure of IP65.
- When it is used indoor, it can be installed in any direction.

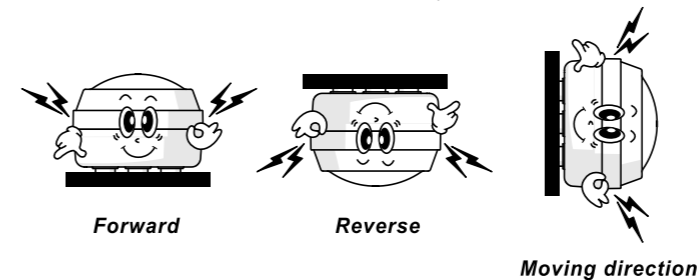

-  - Place to be installed should be the place with less vibration or shock and use it by attaching to flat surface.
- Avoid watery or dusty place if possible.

6. Connection diagram

-  Before wiring, power supply must be turn off.
There is the danger of electrical shock.

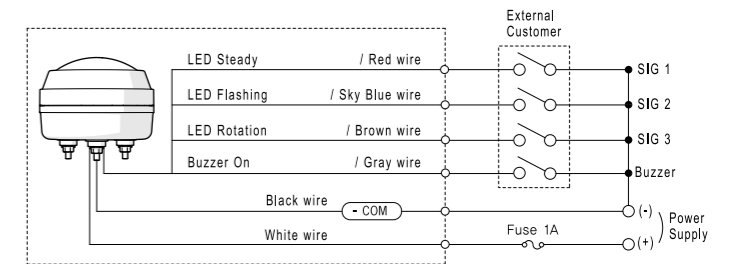

7. Fixed accessory part (Unit: mm)

Well mounting Bracket

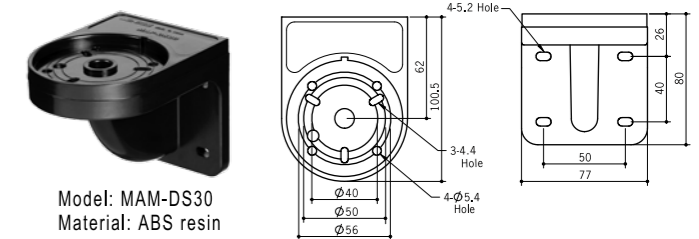

Model: MAM-DS30
Material: ABS resin

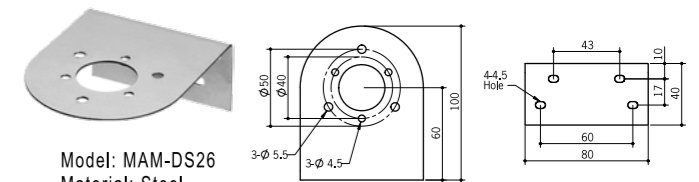

Model: MAM-DS26
Material: Steel

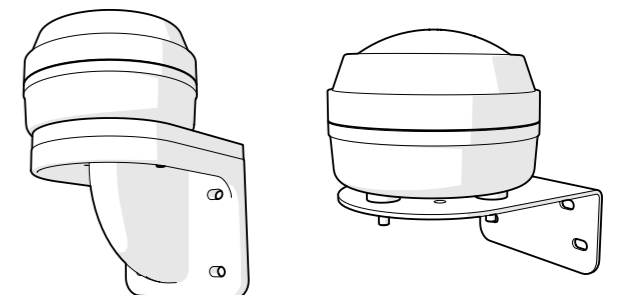

[MAP-DS30]

[MAM-DS26]

※ Outside dimension and performance of the product are subject to change without notice to improve the product.