

Cylindrical Inductive Full-Metal Long-Distance Proximity Sensors



PRFD Series (IO-Link)

PRODUCT MANUAL

For your safety, read and follow the considerations written in the instruction manual, other manuals and Autonics website.

The specifications, dimensions, etc. are subject to change without notice for product improvement. Some models may be discontinued without notice.

Features

- High resistance to impact and wear caused by contact with workpieces or wire brushes (sensor head / housing: stainless steel)
- Reduced risk of malfunction caused by aluminum chips
- Spatter-resistant type
: PTFE coating prevents malfunctions caused by welding spatter
- 360° ring type operation indicator (red LED) (except Ø 8 mm model)
- Oil resistant cable
- Protection rating: IP66, IP67, IP67G, IP68

Safety Considerations

- Observe all 'Safety Considerations' for safe and proper operation to avoid hazards.
- ⚠ symbol indicates caution due to special circumstances in which hazards may occur.

⚠ Warning Failure to follow instructions may result in serious injury or death.

01. Fail-safe device must be installed when using the unit with machinery that may cause serious injury or substantial economic loss. (e.g. nuclear power control, medical equipment, ships, vehicles, railways, aircraft, combustion apparatus, safety equipment, crime/disaster prevention devices, etc.)

Failure to follow this instruction may result in personal injury, economic loss or fire.

02. Do not use the unit in the place where flammable/explosive/corrosive gas, high humidity, direct sunlight, radiant heat, vibration, impact, or salinity may be present.

Failure to follow this instruction may result in explosion or fire.

03. Do not disassemble or modify the unit.

Failure to follow this instruction may result in fire.

04. Do not connect, repair, or inspect the unit while connected to a power source.

Failure to follow this instruction may result in fire.

05. Check 'Connections' before wiring.

Failure to follow this instruction may result in fire.

⚠ Caution Failure to follow instructions may result in injury or product damage.

01. Use the unit within the rated specifications.

Failure to follow this instruction may result in fire or product damage.

02. Use a dry cloth to clean the unit, and do not use water or organic solvent.

Failure to follow this instruction may result in fire.

03. Do not supply power without load.

Failure to follow this instruction may result in fire or product damage.

Cautions during Use

- Follow instructions in 'Cautions during Use'.
Otherwise, it may cause unexpected accidents.
- 10-30 VDC≒ power supply should be insulated and limited voltage/current or Class 2, SELV power supply device.
- Use the product, after 0.8 sec of supplying power.
- Wire as short as possible and keep away from high voltage lines or power lines, to prevent surge and inductive noise.
Do not use near the equipment which generates strong magnetic force or high frequency noise (transceiver, etc.).
In case installing the product near the equipment which generates strong surge (motor, welding machine, etc.), use diode or varistor to remove surge.
- If the surface is rubbed with a hard object, PTFE coating can be worn out.
- This unit may be used in the following environments.
 - Indoors (UL Type 1 Enclosure)
 - Altitude max. 2,000 m
 - Pollution degree 3
 - Installation category II

Cautions for Installation

- Install the unit correctly with the usage environment, location, and the designated specifications.
- Do NOT impacts with a hard object or excessive bending of the wire lead-out. It may cause damage the water resistance.
- When extending wire, use AWG 23 cable or over within 200 m.
In case of IO-Link mode, the cable length between the unit and the IO-Link Master should be under 20 m.
- Factory default is push-pull N.O. mode in SIO mode.
If logical connection (OR, AND) between sensors is required, set the output mode to NPN or PNP.

Ordering Information

This is only for reference, the actual product does not support all combinations. For selecting the specified model, follow the Autonics website.

PRFDCM ① - ② ③ - ④

① DIA. of sensing side

Number: DIA. of sensing side (unit: mm)

③ Power supply

D: 10 - 30 VDC

② Sensing distance

Number: Sensing distance (unit: mm)

④ Communication

IL2: IO-Link COM2

Product Components

- Product × 1
- Instruction manual × 1
- Nut × 2
- Washer × 1

Sold Separately

- M12 Connector cable: C□D(H)3-□
- Fixing bracket: P90-R□
- Spatter protection cover: P90-M□

Communication Interface

■ IO-Link

Version	Ver. 1.1
Class	Class A
Baud rate	COM 2 (38.4 kbps)
Min. cycle time	2.3 ms
Data length	PD: 2 byte, OD: 1 byte (M-sequence: TYPE_2_2)
Vendor ID	899 (0x383)

Software

Download the installation file and the manuals from the Autonics website.

■ atIOLink

atIOLink with purposes for setting, diagnosis, and maintenance of IO-Link device via IODD file is provided as the Port and Device Configuration Tool (PDCT).

- IODD (IO Device Description)

This file contains information such as manufacturer information, process data, diagnostic data, and parameter setting of a sensor using IO-Link communication.

By uploading the IODD file to PDCT Software, you can check the setting and communication data according to the user interface.

Download the IODD file from the Autonics website.

Connections

■ IO-Link mode

- The control output mode can be switched through parameter setting.

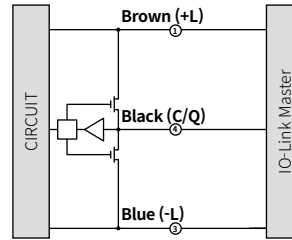

■ SIO mode

- NPN

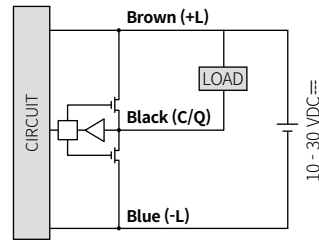

- PNP

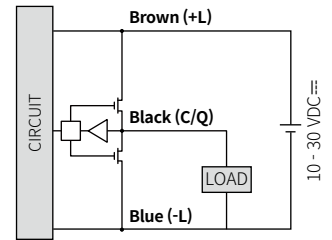

Connector Specification

- For LOAD connection, follow the cable type connection.
- Fasten the connector not to shown the thread. (0.39 to 0.49 N m)
- Fasten the vibration part with PTFE tape.

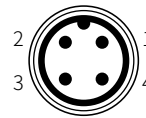

① Brown	② White	③ Blue	④ Black
+L	-	L-	C/Q

Functions

■ Output-related functions

- IO-Link or SIO mode
(Parameter setting possible through software when IO-Link mode)
- Timer mode (Timer OFF (factory default) / ON Delay / OFF Delay / One Shot)
- Timer time (1 to 9999 ms)
- Control output (Push-Pull / NPN / PNP)
- Output mode (N.O. (Normally Open) / N.C. (Normally Closed))
- Operating time save

■ Monitoring functions

- Power monitoring
- Output disconnection detection
- Coil disconnection detection
- Over temperature detection
- Operating time alarm
- Disturbance signal detection

Specifications

Installation	Flush type			
General	PRFDCM08 -2D-IL2	PRFDCM12 -3D-IL2	PRFDCM18 -7D-IL2	PRFDCM30 -12D-IL2
DIA. of sensing side	Ø 8 mm	Ø 12 mm	Ø 18 mm	Ø 30 mm
Sensing distance ⁰¹⁾	2 mm	3 mm	7 mm	12 mm
Setting distance	0 to 1.4 mm	0 to 2.1 mm	0 to 4.9 mm	0 to 8.4 mm
Hysteresis	≤ 15 % of sensing distance			
Standard sensing target: iron	12 × 12 × 1 mm	12 × 12 × 1 mm	30 × 30 × 1 mm	54 × 54 × 1 mm
Response frequency ⁰²⁾	150 Hz	80 Hz	80 Hz	50 Hz
Affection by temperature	≤ ± 20 % for sensing distance at ambient temperature 20 °C			
Indicator ⁰³⁾	IO-Link mode, SIO mode			
IO-Link mode	Communication indicator (flashing green), operation indicator (orange), Abnormal detect indicator (cross-flashing green, orange)			
SIO mode	Operation indicator (orange), stable indicator (green), Abnormal detect indicator (cross-flashing green, orange)			
Certification	CE UK IO-Link			
Unit weight (package)	≈ 10 g (≈ 35 g)	≈ 15 g (≈ 40 g)	≈ 32 g (≈ 67 g)	≈ 85 g (≈ 140 g)

01) Use accessories (nut, washer) made of SUS. Or, sensing distance cannot be guaranteed.

02) The response frequency is the average value. The standard sensing target is used and the width is set as 2 times of the standard sensing target, 1/2 of the sensing distance for the distance.

03) In case of SIO mode, use the device within the range where the stable indicator (green) is ON.
In case of IO-Link mode, use the device within the range where unstable detection (Byte0_bit6) turns 0.

Power supply	10 - 30 VDC≐ (ripple P-P: ≤ 10 %)
Current consumption	≤ 20 mA
Control output	≤ 100 mA
Residual voltage	≤ 2.5 V
Protection circuit	Surge protection circuit, output short over current protection circuit, reverse polarity protection
Insulation resistance	≥ 50 MΩ (500 VDC≐ megger)
Dielectric strength	1,000 VAC~ 50 / 60Hz for 1 minute (between all terminals and case)
Vibration	1.5 mm double amplitude at frequency 10 to 55 Hz in each X, Y, Z direction for 2 hours
Shock	1,000 m/s ² (≈ 100 G) in each X, Y, Z direction for 10 times (DIA. of sensing side Ø 8 mm) : 500 m/s ² (≈ 50 G) in each X, Y, Z direction for 10 times)
Ambient temp. ⁰¹⁾	-25 to 70 °C, storage: -25 to 70 °C (no freezing or condensation)
Ambient humi.	35 to 95 %RH, storage: 35 to 95 %RH (no freezing or condensation)
Protection rating	IP66, IP67 (IEC standard), IP67G (JEM standard), IP68
Connection	Connector models
Connector	M12 plug connector
Material	Case / Nut: stainless steel 303 (SUS303), washer: stainless steel 304 (SUS304), sensing side ⁰²⁾ : stainless steel 303 (SUS303)

01) UL approved surrounding air temperature 60 °C

02) Thickness: DIA. of sensing side Ø 8 mm: 0.2 mm / DIA. of sensing side Ø 12 mm, Ø 18 mm: 0.4 mm / DIA. of sensing side Ø 30 mm: 0.5 mm

Effect of Aluminum Scraps

When aluminum scraps are attached or stacked at sensing side, the proximity sensor does not detect and sensing signal is OFF.

However, the below cases may occur to sensing signal. In this case, remove the scraps.

- When the size of aluminum scraps (d) is bigger than 2/3 of the sensing side size (D)
- When aluminum scraps are attached on the sensing side by external pressure

Sensing side	Size	D (mm)
Ø 8 mm		6
Ø 12 mm		10
Ø 18 mm		16
Ø 30 mm		28

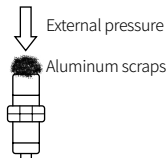

Operation Timing Chart

- Refer to the Setting Distance Formula for the unstable detection area.
Unstable sensing area: 70 % of max. sensing distance

IO-Link mode

- Operates by setting value

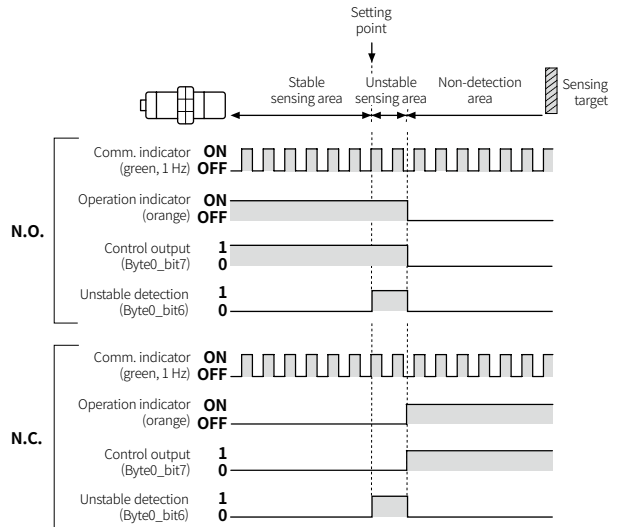

SIO mode

- Operates by factory default

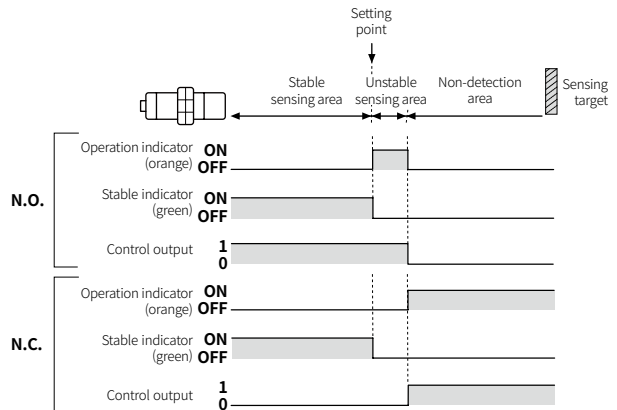

- Example of timer set

T: Timer time (1 to 9999 ms)

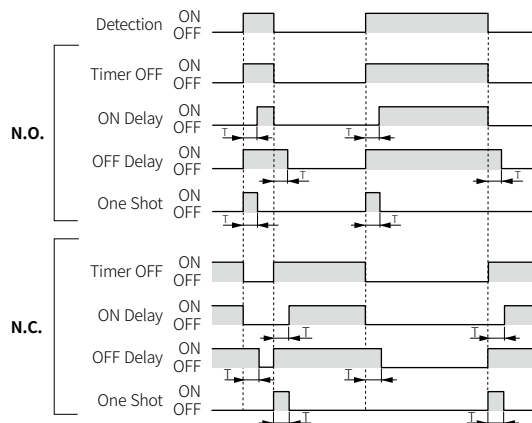

Parameter Index

■ Process data

- The current data value is displayed in real time.

Parameter	Byte0 (PD0)	Byte1 (PD1)	Format	Setting range	Description
Detection Level	-	7 to 0	UInteger	0 to 255	Outputs the detection signal value as specific 8-bit.
Warning	5	-	Boolean	0: Normal (OFF), 1: Warning (ON)	Outputs diagnosing items defined as dangerous.
Instability Detection Alarm	6	-	Boolean	0: Stable, 1: Unstable	Outputs instability detection status.
Sensor Output	7	-	Boolean	0: OFF, 1: ON	Displays sensor's output status. (C/Q terminal)

■ Identification menu

- The device's manufacturer information and sensor information is displayed. It includes additionally information of companies and sensors from the IO-Link standard.

Parameter	Index	Format	R / W	Description
Vendor Name	16	String	RO	Manufacturer name
Vendor Text	17	String	RO	Manufacturer description
Product Name	18	String	RO	Product name
Product ID	19	String	RO	Product ID
Product Text	20	String	RO	Product description
H/W Version	22	String	RO	Hardware version
F/W Version	23	String	RO	Firmware version
Application specific tag	24	String	RW	Application program tag

■ Observation menu

- The device setting value is displayed.

Parameter	Index	R / W	Description
Operating Hours	67	RO	Sensor operation time
Process Data Input	Detection level	RO	Current value
	Warning	RO	Warning
	Instability detection alarm	RO	Unstable detection
	Sensor output	RO	Sensor output

■ Parameter menu

- Product settings such as output mode and timer can be changed according to the user environment.

Parameter	Index	Sub-index	Format	R / W	Description	Setting range	Factory default
Output Setup	64	1	UInteger	RW	Output mode	0: N.O. (Normally Open), 1: N.C. (Normally Closed)	0
		2	UInteger	RW	Output type	0: Push-Pull, 1: NPN, 2: PNP	0
Timer	65	1	UInteger	RW	Timer mode	0: Timer OFF, 1: ON Delay, 2: OFF Delay, 3: One Shot	0
		2	UInteger	RW	Timer time	1 to 9,999 ms	5 ms
Instability Detection Alarm	66	-	UInteger	RW	Output timing when instable detection	0: 0 ms, 1: 10 ms, 2: 50 ms, 3: 100 ms, 4: 300 ms, 5: 500 ms, 6: 1000 ms	4
Operating Hours Alarm Setting	68	-	UInteger	RW	Operating Hours Alarm Setting	0 to 131,071 hour	100,000
Restore Factory Settings	2	-	UInteger	WO	Factory default reset	130: Restore factory setting	-
Data Storage Lock	12	2	Record	RW	Data storage locked between IO-Link Master-Device	0: false, 1: true	0

■ Diagnosis Menu

- The information about problems encountered during sensor operation is displayed.

Parameter	Index	Format	R / W	Description
Operating Hours	67	UInteger	RO	Sensor operation time
Process Data Input	Detection Level	UInteger	RO	Current value
	Warning	Boolean	RO	Warning
	Instability Detection Alarm	Boolean	RO	Unstable detection
	Sensor Output	Boolean	RO	Sensor output
Detailed Device Status	37	Record	RO	Sensor detailed status

■ Events

- When the corresponding error occurs, the abnormal indicator flashes.

Event name	Event code	Type	Description
Warning	6148 (0x1804)	Over Temperature	Overheat detection warning
	6151 (0x1807)	Supply Under Voltage	Low voltage detection warning
	6164 (0x1814)	Coil Disconnecton	Coil disconnection detection warning
	6165 (0x1815)	Short Circuit	Overcurrent detection warning
	6166 (0x1816)	Operating Time Alarm	Operation time alarm warning
	6167 (0x1817)	Disturbance Error	Disturbance signal detection warning
	6168 (0x1818)	EEPROM Error	EEPROM error warning
Error	6157 (0x180D)	Parameter Setting Error	Parameter setting error

Cut-out Dimensions

• Unit: mm, For the detailed drawings, follow the Autonics web site.

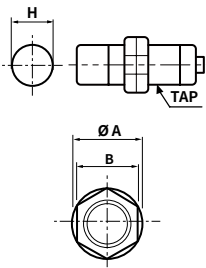

	Ø 8 mm	Ø 12 mm	Ø 18 mm	Ø 30 mm
Mounting hole (H)	Ø 8.5 ^{+0.5} ₀	Ø 12.5 ^{+0.5} ₀	Ø 18.5 ^{+0.5} ₀	Ø 30.5 ^{+0.5} ₀
TAP	M8×1	M12×1	M18×1	M30×1.5

	Ø 8 mm	Ø 12 mm	Ø 18 mm	Ø 30 mm
Ø A	15	21	29	42
B	13	17	24	36

Setting Distance Formula

• Detecting distance can be changed by the shape, size or material of the target.
For stable sensing, install the unit within the 70 % of sensing distance.

$$\text{Setting distance (Sa)} = \text{Sensing distance (Sn)} \times 70\%$$

• When the sensing target is placed over approx. 70% of sensing distance (Sn), the operation indicator (orange) turns ON. When the target is placed within approx. 70 % of sensing distance (Sn), the stability indicator (green) turns ON.
Use the sensor at the position where the stability indicator turns ON.

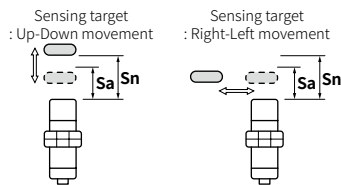

Mutual-interference & Influence by Surrounding Metals

■ Mutual-interference

When plural proximity sensors are mounted in a close row, malfunction of sensor may be caused due to mutual interference.

Therefore, be sure to provide a minimum distance between the two sensors, as below table.

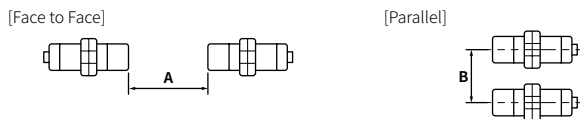

■ Influence by surrounding metals

When sensors are mounted on metallic panel, it must be prevented sensors from being affected by any metallic object except target. Therefore, be sure to provide a minimum distance as below chart.

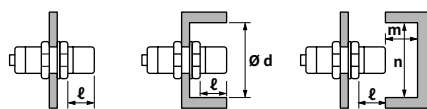

(unit: mm)

Sensing side	Ø 8 mm	Ø 12 mm	Ø 18 mm	Ø 30 mm
Item				
A	35	40	65	110
B	30	35	60	100
l	0	0	0	0
Ø d	8	12	18	30
m	4.5	8	20	40
n	30	40	60	100

Tightening Torque

Use the provided washer to tighten the nuts.

The allowable tightening torque table is for inserting the washer as below.

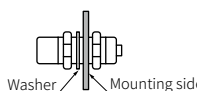



Sensing side	Ø 8 mm	Ø 12 mm	Ø 18 mm	Ø 30 mm
Strength				
Tightening torque	3.5 N m	25 N m	70 N m	180 N m

Durability Test

High resistance to the impact of removing Welding sludge attached to the sensing face

■ Metallic brush test

• Test model: PRFD18, testing object: stainless cup brush, rotation speed: 80 RPM, testing time: 3 hours

Test conditions	Result
	

Electromagnetic Resistance Test

Large current from welding generates magnetic field which can affect the proximity sensor to malfunction due to noise. This product, however, can be used near strong noise without malfunctioning, thanks to excellent electromagnetic resistance.

This test is conducted in the environment of welding. Minimum sensing distance can be different by welding environment.

• Test model: all Series, welding current: 13,000 A, installation direction: front and side

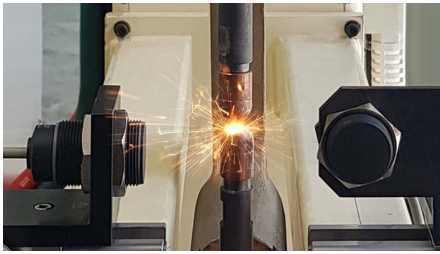
Test conditions	Remarks
	Recommended to use spatter protection cover (sold separately) for general type.

■ Minimum sensing distance between weld and sensor

Sensing side	Ø 8 mm	Ø 12 mm	Ø 18 mm	Ø 30 mm
Installation direction				
Front	10 mm	10 mm	40 mm	50 mm
Side	10 mm	10 mm	50 mm	60 mm

IP67G (JEM standard)

■ Used oil (for reference only)

Oil type	JIS standard	Oil name	Kinetic viscosity (mm ² /s, 40°C)	PH
Lubricating oil	—	Velocite Oil No.3	2	—
Water-insoluble cutting fluid	2-5	Tectyl Cut 527	27	—
Water-soluble cutting fluid	—	Tectyl Cool 263C	—	9.5 (10% Solution)

• IP67G means oil (drops and powders) from all directions completely blocked. It obtains the protection rating of enhanced oil resistance. (Pass the dropping test for 48 hours with the above oil)

Sensing Distance Feature Data by Target Material and Size

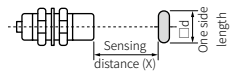

• Ø 8 mm

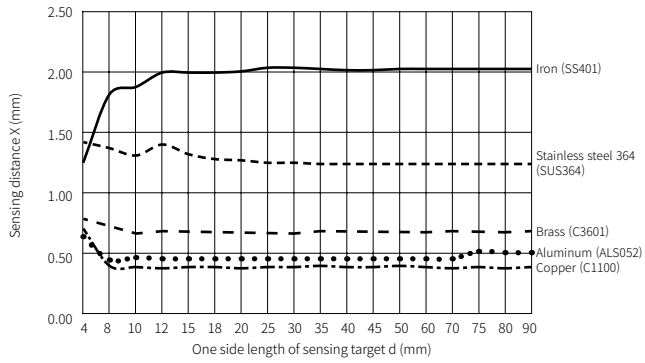

• Ø 12 mm

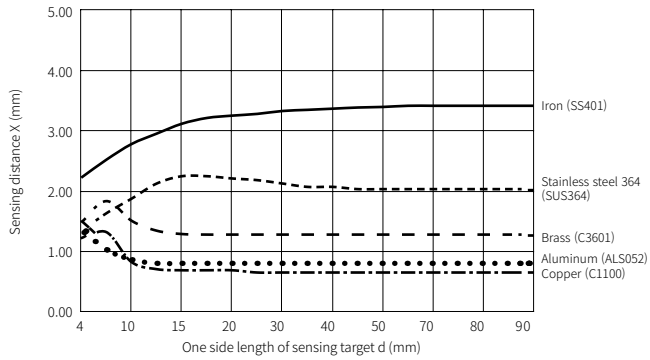

• Ø 18 mm

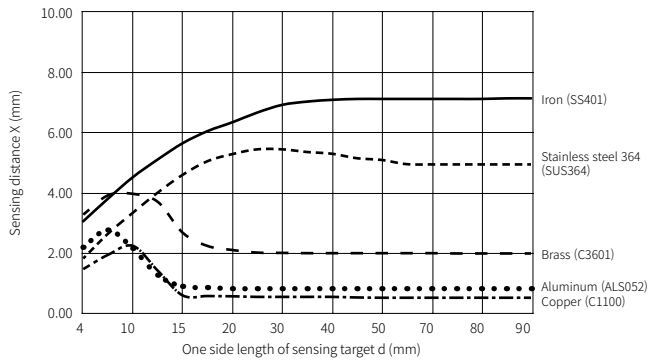

• Ø 30 mm

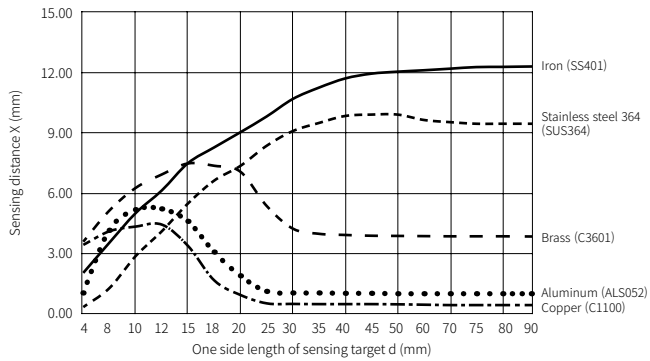

Sensing Distance Feature Data by Parallel (left/right) Movement

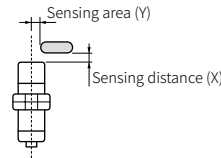

• Ø 8 mm

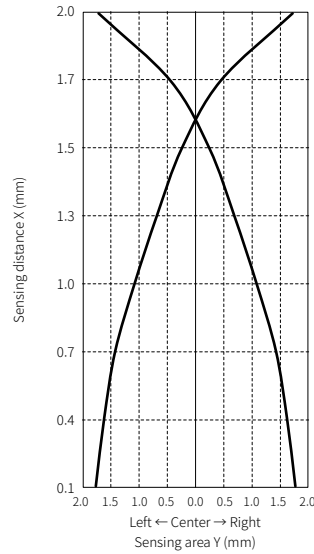

• Ø 12 mm

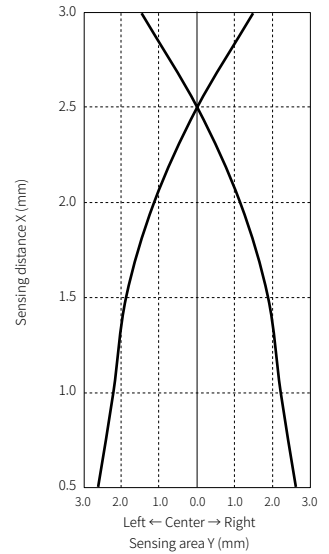

• Ø 18 mm

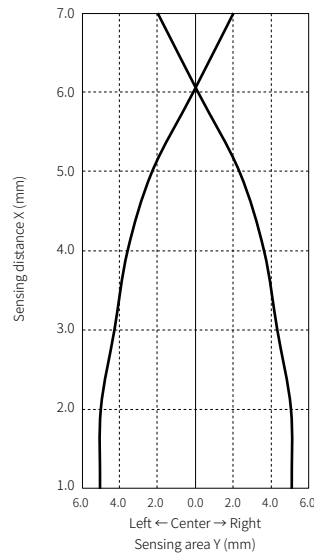

• Ø 30 mm

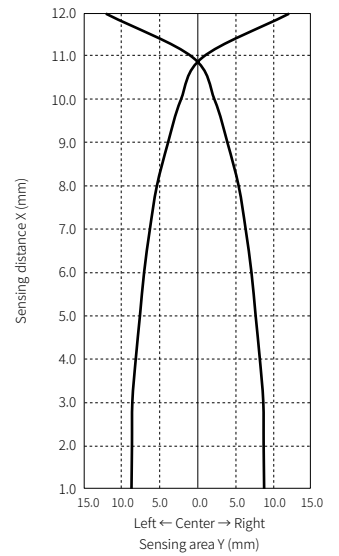

Sold Separately: M12 Connector Cable

• For detailed information, refer to the 'M8/M12 Connector Cable' manual.

Appearance	Power	Connector 1	Connector 2	Length	Feature	Model
	DC	M12 (Socket-Female) 4-pin	3-wire	2 m	PVC	CID3-2
				5 m		CID3-5
	DC	M12 (Socket-Female) 4-pin	3-wire	2 m	Oil resistant PVC	CIDH3-2
				5 m		CIDH3-5
	DC	M12 (Socket-Female) 4-pin, L type	3-wire	2 m	PVC	CLD3-2
				5 m		CLD3-5
	DC	M12 (Socket-Female) 4-pin, L type	3-wire	2 m	Oil resistant PVC	CLDH3-2
				5 m		CLDH3-5

Sold Separately: Protection Cover (P90-M□)

The welding tip (spatter) generated during arc welding has a property of sticking to plastics and metals. If several welding tips are attached to the front or body of the proximity sensor, it may be difficult to replace the body or cause a malfunction. When using a general type proximity sensor, use a silicone protective cover (sold separately). Only for flush (shield) type.

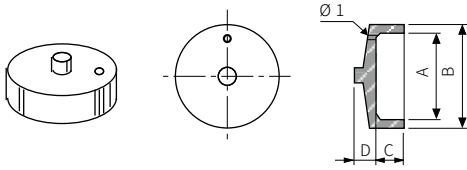

Item (mm)	Model	P90-M12	P90-M18	P90-M30
A		Ø 11	Ø 17	Ø 28.5
B		Ø 14	Ø 21	Ø 33
C		5.0	6.0	8.0
D		1.0	3.0	6.0
Applied sensing side size		M12	M18	M30

Sold Separately: Fixing Bracket (P90-R□)

If fixing holes are not made for cylindrical proximity sensor, use a cylindrical fixing bracket as below. For Non-flush (non-shield) type, be sure effect by ambient material.

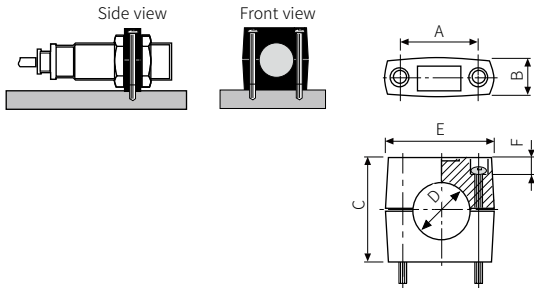

Item (mm)	Model	P90-R12	P90-R18	P90-R30
A		24 ± 0.2	32 ± 0.2	45 ± 0.2
B		≤ 11.5	≤ 16	≤ 16
C		20	30	50
D		Ø 12	Ø 18	Ø 30
E		≤ 34.4	≤ 47	≤ 60
F		6.0	10	10
Fixing bolt		M4 × 20	M5 × 30	M5 × 50
Applied sensing side size		M12	M18	M30