

Safety Slim Type Door Lock Switch



SFDL2 Series PRODUCT MANUAL

For your safety, read and follow the considerations written in the instruction manual, other manuals and Autonics website.

The specifications, dimensions, etc. are subject to change without notice for product improvement. Some models may be discontinued without notice.

Main Features

- Slim size W 90 x H 105 x D 35.5 mm
- Head unit can be rotated to change insert direction of operation key
: Operation key can be inserted from 4 directions (top/sides)
- Various contact types (up to 6-contacts)
: Lock N.C. 2/N.O. 1+Door N.C. 2/N.O.1
Lock N.C. 3+Door N.C. 2/N.O.1
Lock N.C. 2/N.O. 1+Door N.C. 3
Lock N.C. 3+Door N.C. 3
- Manual unlock function (release key) for emergencies during installation or testing
: Standard (cross) type and special type release keys, rear release button
- Two lock-release methods
: Mechanical lock-solenoid release, solenoid lock-mechanical release models
- Different installation types depending on operation key insertion position
: Front / rear installation models
- Excellent strength and durability with metal head model

Safety Considerations

- Observe all "Safety Considerations" for safe and proper operation to avoid hazards.
- ⚠ symbol indicates caution due to special circumstances in which hazards may occur.

⚠ Warning Failure to follow instructions may result in serious injury or death.

- 01. Fail-safe device must be installed when using the unit with machinery that may cause serious injury or substantial economic loss. (e.g. nuclear power control, medical equipment, ships, vehicles, railways, aircraft, combustion apparatus, safety equipment, crime/disaster prevention devices, etc.)**
Failure to follow this instruction may result in personal injury, economic loss or fire.
- 02. System manager means followings;**
- a personnel who is fully aware of installation, setting, operation, and maintenance of the product
- a personnel who well observes standard/regulation/statute on the product by type of machine the product installed in and nation/region the product used in
Machine user means a personnel who is appropriately trained about using machine by the system manager, so that machine user can operate the machine correctly.
System manager has duty to train the machine user about operation of the product.
Machine user has to report directly to the system manager when unusual status has been found while system is operating.
Failure to follow this instruction may result in personal injury, economic loss or fire.
- 03. The product has to be installed, set, and combined with machine control system by the qualified system manager.**
Failure to follow this instruction may result in personal injury due to unintended operation and unstable detection.
- 04. Before using the product, check that function of the product operates as intended while machine is turned off after installation.**
Failure to follow this instruction may result in personal injury due to unintended operation and unstable detection.
- 05. Do not use the unit in the place where flammable/explosive/corrosive gas, high humidity, direct sunlight, radiant heat, vibration, impact, salinity, moisture, or steam, or dust may be present.**
Failure to follow this instruction may result in explosion or fire.
- 06. Do not disassemble or modify the unit.**
Failure to follow this instruction may result in personal injury or fire due to loss of safety function.
- 07. Do not connect, repair, inspect, or replace the unit while connected to a power source.**
Failure to follow this instruction may cause the external devices connected to the product may unexpectedly operate. Failure to follow this instruction may result in fire.
- 08. Do not defeat, tamper, modify, or bypass the switch and enter the door.**
Failure to follow this instruction may result in personal injury.
- 09. Be cautious about the installing place of the operation key in order to protect worker from hitting the operation key when the door is opened.**
Failure to follow this instruction may result in personal injury.
- 10. Do not use a head of other product.**
Failure to follow this instruction may result in personal injury or fire due to loss of safety function.
- 11. Install separate safety device to fix door closed, or door can be opened because of vibration or weight of the door.**
Failure to follow this instruction may result in personal injury.
- 12. Check the installed status of the switch, operating status of the switch, and signs of damage, modification, tampering of the switch at the following situation and on a weekly basis.**
- when operating the safety system at first
- when replacing component of the system
- when the system has not been operated for a long time
Failure to follow this instruction may result in personal injury due to malfunction of the product and safety function.
- 13. Solenoid Lock/Mechanical Release type switch is locked with power connected and is unlocked without power. Be cautious that the switch can be unlocked before complete stop of the machine when blackout occurs.**
Failure to follow this instruction may result in personal injury.
- 14. Check "Connections" before wiring. And make sure that there are no safety problems.**
Failure to follow this instruction may result in personal injury or fire due to loss of safety function.

⚠ Caution Failure to follow instructions may result in injury or product damage.

- 01. Use the unit within the rated specifications.**
Failure to follow this instruction may result in fire or product damage.
- 02. Since solenoid has polarity, wire cables and supply voltage ensuring correct polarity. Do not supply voltage above the rated voltage specification.**
Failure to follow this instruction may result in fire or solenoid damage.
- 03. Be sure to install the cover after wiring work, and do not apply power with the cover open.**
Failure to follow this instruction may result in electric shock.
- 04. Use a dry cloth to clean the unit, and do not use water or organic solvent.**
Failure to follow this instruction may result in fire.
- 05. Keep the door switch away from debris and tighten the screw securely when replacing the head.**
Failure to follow this instruction may result in malfunction.
- 06. Keep the product away from metal chip, dust, and wire residue which might flow into the unit.**
Failure to follow this instruction may result in fire, product damage or malfunction.
- 07. Do not use metallic cable gland.**
Failure to follow this instruction may result in electric shock due to the damage on the service entrance.
- 08. Do not use the switch as a guard door stopper. Install separate mechanical stopper.**
Failure to follow this instruction may result in product damage.
- 09. Carefully manage the spare operation key in order to prevent use of the key without permission.**
Failure to follow this instruction may result in loss of safety function due to insertion of the spare operation key.
- 10. Use only Autonics operation key.**
Failure to follow this instruction may result in product damage.

- Install the operation key tightly within the range written in 'Installation' with welding, rivet, or special bolt in order not to be easily released from the switch.
Failure to follow this instruction may result in product damage.
- When it comes to the Solenoid Lock/Mechanical Release model, make it to be locked by supplying power after the door is closed.
Failure to follow this instruction result in malfunction, if the power is supplied when the door is opened.
- When changing the direction of the head, make sure that the cam inside the head does not rotate.
Failure to follow this instruction result in malfunction.

Cautions during Use

- Follow instructions in 'Cautions during Use'. Otherwise, it may cause unexpected accidents.
- Use the switch with the dedicated controller. Do not use the switch with another controller randomly.
- This unit may be used in the following environments.
 - Indoors (in the environment condition rated in 'Specifications')
 - Altitude max. 2,000m
 - Pollution degree 3
 - Installation category III
 - Enclosure Type 1

Product Components

- Product
- Instruction manual
- Special type release key (Special type release key model)

Sold Separately

- Operation key: SFD-K□□
- Rear release extension button (SFDL2-RE□□)
- Safety door lock slide unit: SFDL2-SD
- Group locking device: SFD-LT□□ / Connecting cable: SFD-LT-C□□

Ordering Information

This is only for reference, the actual product does not support all combinations. For selecting the specified model, follow the Autonics website.

SFDL2 - ① ② ③ - ④ ⑤ ⑥ ⑦ - ⑧

① Head material

No mark: Metallic
P: Plastic

② Lock/Release method

M: Mechanical Lock/Solenoid Release
S: Solenoid Lock/Mechanical Release

③ Contact composition

6A: Lock 2 N.C./1 N.O. + Door 2 N.C./1 N.O.
6B: Lock 3 N.C. + Door 2 N.C./1 N.O.
6C: Lock 2 N.C./1 N.O. + Door 3 N.C.
6D: Lock 3 N.C. + Door 3 N.C.

④ Installation direction

No-mark: Front installation
B: Rear installation

⑤ Connection outlet specification

M20: M20 thread
G1/2: G1/2 thread

⑥ Release key type

No-mark: Cross type
K: Special type

⑦ Rear release button

No-mark: None
B: Exist

⑧ Release key position

No-mark: Front
T: Bottom

Specifications

Model	SFDL2-□□□-□□□-□□□ SFDL2-□□□-□□□K-□□□	SFDL2-□□□-□□□ B-□□□ SFDL2-□□□-□□□KB-□□□
Directing opening force	≥ 80 N	
Directing opening distance	≥ 10 mm	
Locking pullout strength	≥ 1,300 N	
Operating speed	0.05 to 1 m/s	
Operating frequency	≤ 20/min	
Mechanical life cycle	≥ 1,000,000 operations (20/min)	
Indicator	Solenoid status or contact status (orange, depending on connection)	-
Vibration (malfunction)	0.35mm amplitude at frequency of 10 to 55 Hz in each X, Y, Z direction for 10 min	
Shock	1,000 m/s ² (≈ 100 G) in each X, Y, Z direction for 3 times	
Shock (malfunction)	80 m/s ² (≈ 8 G) in each X, Y, Z direction for 3 times	
Ambient temperature	-10 to 55°C, storage: -25 to 65°C (a non freezing or condensation environment)	
Ambient humidity	35 to 85%RH, storage: 35 to 85%RH (a non freezing or condensation environment)	
Protection structure	IP67 ⁽¹⁾ (IEC standard, except for head)	
Material	Head: zinc or PA, case: PA	
Approval	CE (TUV NORD) UK (BSI) S (SE) ENEC	
Accessory	SFDL2-□□□-□□□K/KB-□□□ (Special type release key): rotating key	
Unit weight (packaged)	Normal type: ≈ 400 g (≈ 490 g), rear release button type: ≈ 395 g (≈ 485 g)	

(1) Rated protection structure is for the switch body. Be cautious about preventing the head part from entering the foreign materials such as dust and water.

Contact block

Rated voltage/current for load	Resistive load: 6 A/250 VAC~, 0.6 A/250 VDC= Inductive load (IEC): AC-15 3 A/240 VAC~, DC-13 0.27 A/250 VDC= Inductive load (UL): A300, Q300
Impulse dielectric strength	Between the terminals of same polarity: 2.5 kV Between the terminals of different polarity: 4 kV Between each terminal and non-live part: 6 kV
Insulation resistance	≥ 100 MΩ (500 VDC = megger)
Contact resistance	≤ 100 mΩ
Electrical life cycle	≥ 100,000 operations (250 VAC~/6 A)
Conditional short-circuit current	100 A

Solenoid

Rated voltage	24 VDC=, class 2
Current consumption	Supplying power: 0.26A Normal: max. 0.2A (approx. 3 seconds after supplying power)
Insulation class	Class E

Indicator LED

Rated voltage	24 VDC=
Current consumption	2.2 mA

Contact Composition and Operation

Connection diagram represents the locked status with the operation key inserted.

■ ON, □ OFF, ⊕ Direct opening action possible

Model	Contact (lock monitor+ door monitor)	Connection diagram		Contact operation
		Door monitor	Lock monitor	
SFDL2-□□6A -□□□-□	2N.C./1N.O.+ 2N.C./1N.O.			
SFDL2-□□6B -□□□	3N.C.+2N.C./1N.O.			
SFDL2-□□6C -□□□	2N.C./1N.O.+3N.C.			
SFDL2-□□6D -□□□	3N.C.+3N.C.			

Status Indicator

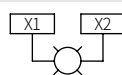

The status indicator operates at 24 VDC regardless of polarity. Depending on the connection of X1 and X2 contact, it is possible to display the status wanted.

Installation

- The head of the switch can be rotated by loosening the four screws from the corners of the head and reinstalling the head in the desired orientation.
- Be sure to install the switch with the minimum radius at a hinged door as shown in the table. For more information about operation keys, refer to the product manual.

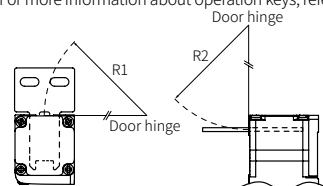

Operation key	Minimum radius	
	R1	R2
SFD-KH	300 mm	300 mm
SFD-KL		
SFD-KHR		
SFD-KLR		
SFD-KLF	50 mm	300 mm
SFD-KLF2		

- Inspect the inserted operation key remains within the set zone (0.5 to 3 mm).
- Recommended screw tightening torque

Set zone: 0.5 to 3 mm

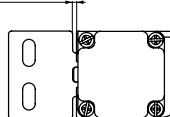

Screw	Tightening torque
Terminal screw (M3.5)	0.6 to 0.8 N m
Terminal block screw (M3)	0.3 to 0.5 N m
Cover screw (M3)	0.7 to 0.9 N m
Head mounting screw (M3)	0.7 to 0.9 N m
Cable gland	2.7 to 3.3 N m
M20 NUT, G1/2 NUT	1.3 to 1.5 N m

- Install the operation key within ±1 mm from the center of the operation key hole (SLOT).
- Cable gland specification and recommended product

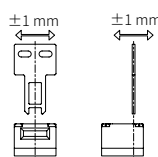

Thread spec	MFR	Model	Cable Ø
G1/2	CP	FCGL-G12B	4 - 8 mm
	SYSTEM	FCGL-G16B	7 - 12.3 mm
M20	LAPP	ST-M20X1.5 / 5311-1020	6 - 13 mm

- In case of using the cable gland with the 9 mm screw thread or longer, a gap between the switch and cable may affect the protection structure.

- When closing the cover, set the release key to the LOCK position. It may cause product damage.
- If the seal rubber is detached or lifted, or if foreign substances are attached to the seal rubber, it may cause deterioration of the sealing force. Check that there is no problem with the seal rubber before use.
- Do not use other than regular screws. There is a risk that the sealing power may decrease.

Connections

- When wiring with the ring crimp terminal, connect the terminals as shown in figure for the cable not to override to the case and cover.
- Use the UL approved ring crimp terminal listed in below. Bend the terminal as shown in figure to use.

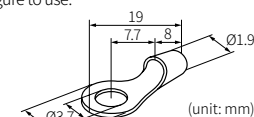
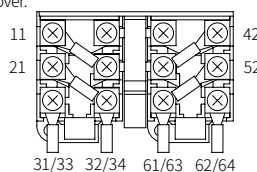

Manufacturer	Model
JST	FN0.5-3.7 (flared type) N0.5-3.7 (straight type)

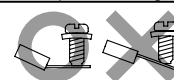

Manual Unlock

- Do not use the release key or rear release button to stop the machine.

Release key

Release key	Normal	Manual unlock
Cross type		
Special type		

- Release key position

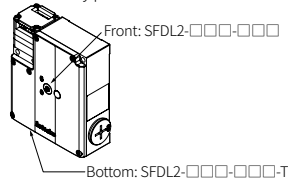

- You can manually unlock the switch in the emergency situation such as blackout, when wiring, before supplying power, or when testing operation of the switch.
- When using the release key, turn it to the marked position completely. Otherwise (under 90°), switch can be damaged or malfunction.
- Do not apply the power over 0.2 N·m on the release key. It can be result in product damage.

Rear release button

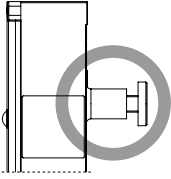

- It is possible to manually unlock by pressing the rear release button. Use only for emergency evacuation when workers are trapped in the work area.
- When using the rear release button, press it all the way down, and after use, pull it all the way back to its original state. Otherwise, the switch may be damaged or may not function properly.
- The door will not lock while the button is pressed.
- It is possible to extend the button length with the rear release extension button (sold separately: SFDL2-RE□□□). For more information, refer to the product manual.

Dimensions

- Unit: mm, For the detailed dimensions of the product, follow the Autonics web site.

Front installation

- The parts marked with a dotted line are dimensions applicable only to the rear release button existing type.

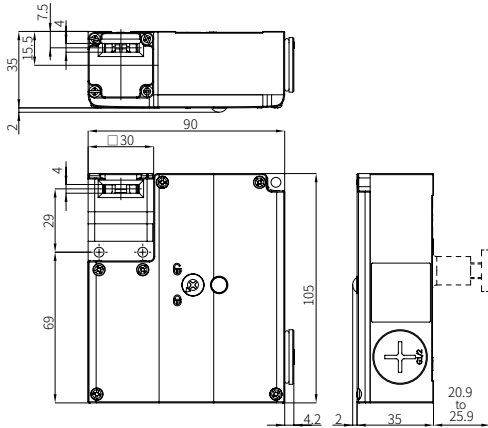

Rear installation

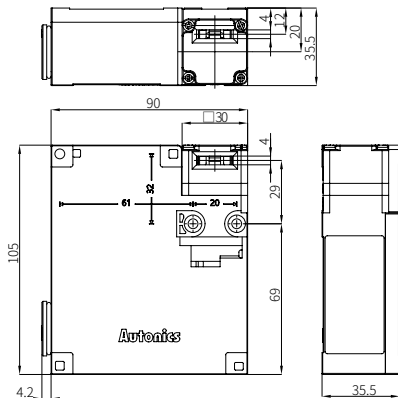

Panel cut-out

- Front installation

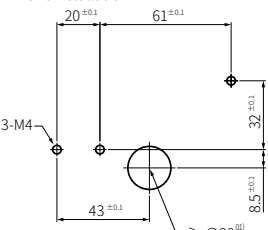

- Rear installation

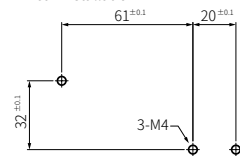

01) Equipped with the rear release extension button(sold separately): $\geq \text{Ø}25$

Unit Descriptions

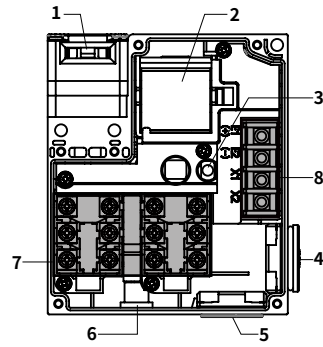

1. Operation key hole (SLOT)
2. Solenoid
3. LED indicator
4. Conduit outlet(horizontal)
5. Conduit outlet(vertical)
6. Release key

7. Contact terminal

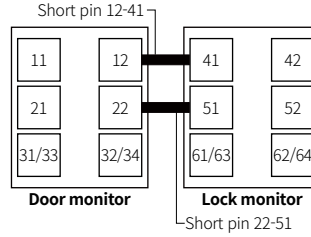

8. Solenoid/Indicator power terminal

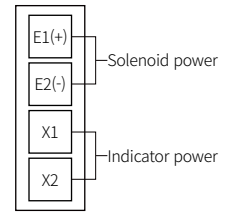

Sold Separately: Operation Key (SFD-K)

• Unit: mm, For the detailed dimensions of the product, follow the Autonics web site.

■ SFD-KH

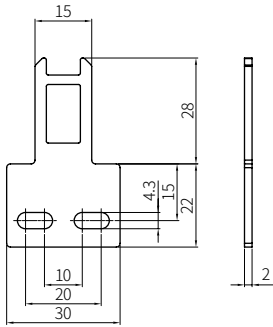

■ SFD-KL

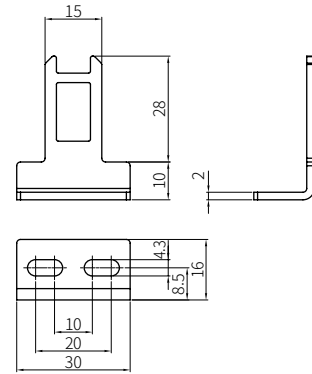

■ SFD-KHR

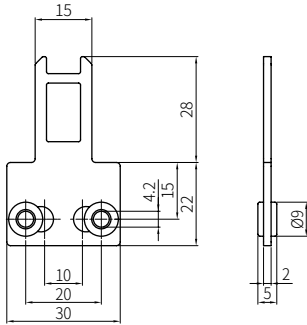

■ SFD-KLR

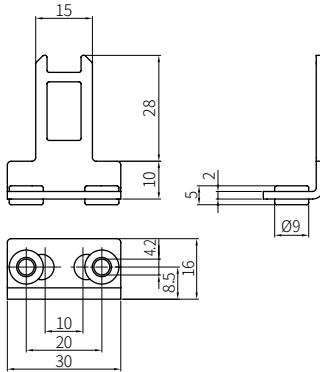

■ SFD-KLF, SFD-KLF2

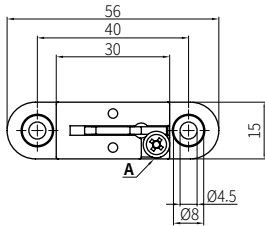

- When installing the switch on a hinged door, turn the angle adjustment screw to adjust the inclination of the control key toward the door hinge.

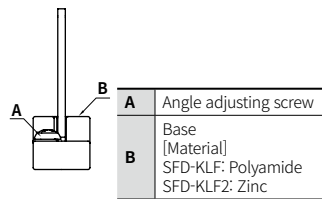
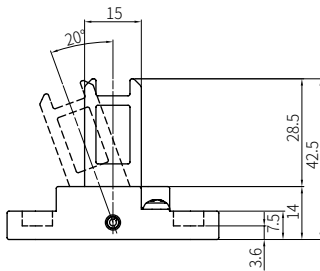
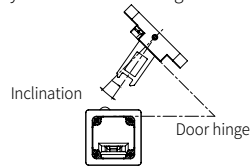

Sold Separately: Rear Release Extension Button (SFDL2-RE)

• Unit: mm, For the detailed dimensions of the product, follow the Autonics web site.

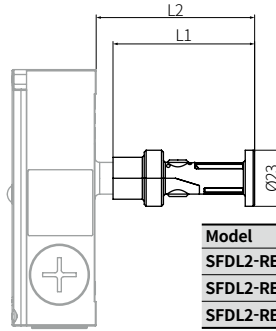

Model	Unit length (L1)	Protrusion length (L2)
SFDL2-RE40	59	60.9 to 65.9
SFDL2-RE60	79	80.9 to 85.9
SFDL2-RE120	139	140.9 to 145.9

■ Installation

1. Combine 2 parts in both directions of the release button for temporary assembly.
2. Tighten the bolt to fasten the product.

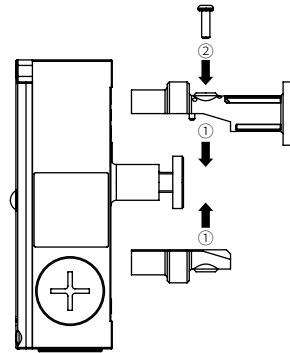

■ Cautions

- Do not allow the rear release extension button to protrude more than 30mm out of the panel. Failure to follow this instruction may result in product damage.
- Do not apply any impact or force except the button's operating direction. Failure to follow this instruction may result in product damage.

Sold Separately: Group Locking Device (SFD-LT□) / Connecting Cable (SFD-LT-C□)

The group locking device is mounted on the operation key insertion hole (SLOT) to prevent arbitrary operation by the operator.

Model	SFD-LT	SFD-LT2
Type	Side inserted type	Upside inserted type
Head material of the applied model	Metal	
Padlock ring diameter	Ø 5 to 7 mm	
Load	Max. 30 N	
Shock	300 m/s ² (≈ 30 G) X, Y, Z direction for 3 times	
Vibration	0.35 mm amplitude at frequency of 10 to 55 Hz in each X, Y, Z direction for 10 min	

Side inserted type: SFD-LT

- Unit: mm, For the detailed dimensions of the product, follow the Autonics web site.

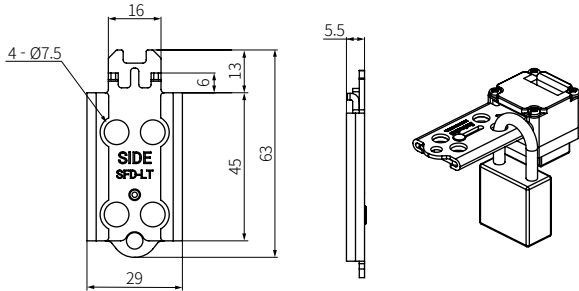

Upside inserted type: SFD-LT2

- Unit: mm, For the detailed dimensions of the product, follow the Autonics web site.

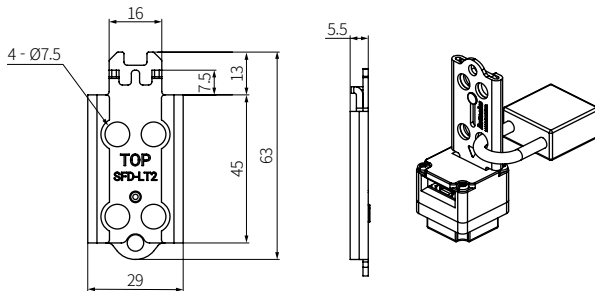

Cautions

- Head material: Use for the metal head of applied models.
- Select the padlock locked in the group locking device to be less than 2 kg. Failure to follow this instruction may result in product or safety switch damage.
- Do not apply excessive shock and vibration while installed in the group locking device. Failure to follow this instruction may result in product or safety switch damage.
- Install the group locking device to prevent interrupting other nearby devices.
- Fasten the group locking device in the correct direction.

SFD-LT

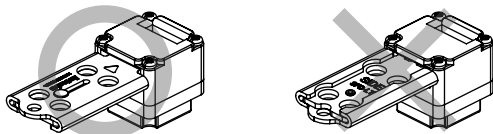

SFD-LT2

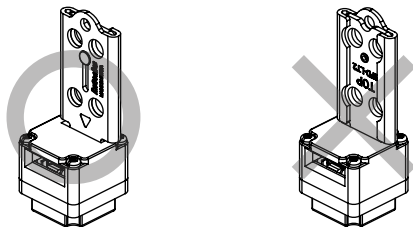

Installation

- This is the installation example of the side inserted type.

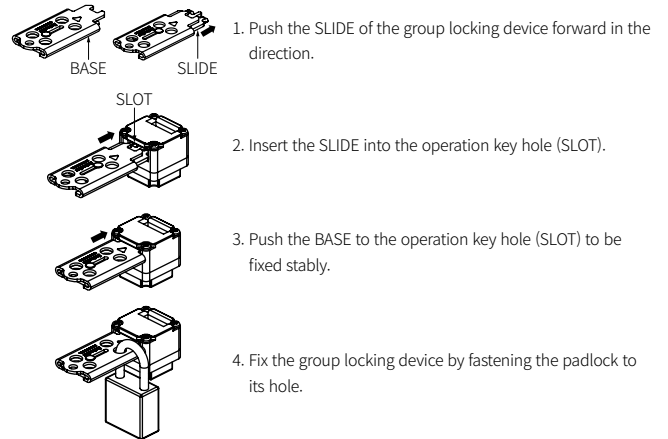

Group locking device connecting cable: SFD-LT-C□

- It is possible to prevent loss of the group locking device with the connecting cable (SFD-LT-C□).
- The connecting ring is connected to the group locking device, and the retaining ring is used by fixing it around the switch (within the available distance of the group locking device).
- Unit: mm, For the detailed dimensions of the product, follow the Autonics web site.

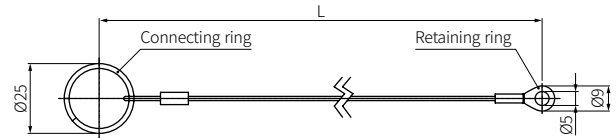

Model	Length (L)
SFD-LT-C20	200
SFD-LT-C30	300
SFD-LT-C40	400