

# Single-Phase Socket SSR With Detachable Heatsink



## SRS1 Series PRODUCT MANUAL

For your safety, read and follow the considerations written in the instruction manual, other manuals and Autonics website.

The specifications, dimensions, etc. are subject to change without notice for product improvement. Some models may be discontinued without notice.

### Features

- Dielectric strength : 2,500 VAC~
- Rated input voltage
  - SRS1-A: AC, DC, AC / DC
  - SRS1-B: AC
  - SRS1-C: AC, DC, AC / DC
- Socket type for easier installation and maintenance
  - SRS1-A: Autonics SK-G05 sockets
  - SRS1-B: General LY2 sockets
  - SRS1-C: General MY4 sockets
- Zero cross turn-on, random turn-on models available
- Input indicator (red)

### Safety Considerations

- Observe all 'Safety Considerations' for safe and proper operation to avoid hazards.
- ⚠ symbol indicates caution due to special circumstances in which hazards may occur.

**⚠ Warning** Failure to follow instructions may result in serious injury or death.

- 01. Fail-safe device must be installed when using the unit with machinery that may cause serious injury or substantial economic loss.** (e.g. nuclear power control, medical equipment, ships, vehicles, railways, aircraft, combustion apparatus, safety equipment, crime/disaster prevention devices, etc.)  
Failure to follow this instruction may result in personal injury, economic loss or fire.
- 02. Do not use the unit in the place where flammable/explosive/corrosive gas, high humidity, direct sunlight, radiant heat, vibration, impact or salinity may be present.**  
Failure to follow this instruction may result in explosion or fire.
- 03. Do not connect, repair, or inspect the unit while connected to a power source.**  
Failure to follow this instruction may result in fire or electric shock.
- 04. Check 'Connections' before wiring.**  
Failure to follow this instruction may result in fire.
- 05. Do not disassemble or modify the unit.**  
Failure to follow this instruction may result in fire or electric shock.

**⚠ Caution** Failure to follow instructions may result in injury or product damage.

- 01. Use the unit within the rated specifications.**  
Failure to follow this instruction may result in fire or product damage.
- 02. Use a dry cloth to clean the unit, and do not use water or organic solvent.**  
Failure to follow this instruction may result in fire or electric shock.
- 03. Keep the product away from metal chip, dust, and wire residue which flow into the unit.**  
Failure to follow this instruction may result in fire or product damage.
- 04. Since leakage current still flows right after turning off the power or in the output OFF status, do not touch the load terminal.**  
Failure to follow this instruction may result in electric shock.

### Cautions during Use

- Follow instructions in 'Cautions during Use'.  
Otherwise, it may cause unexpected accidents.
- Power supply should be insulated and limited voltage/current or Class 2, SELV power supply device.
- Install the unit in the well ventilated place.
- While supplying power to the load or right after turning off the power of the load, do not touch the body and heat sink. Failure to follow this instruction may result in burn due to high temperature of the surface.
- In order to protect the product from the short-circuit current of the load, use rapid fuse of which I<sup>t</sup> is under the 1/2 of SSR I<sup>t</sup>. When short-circuited, replace the fuse to those of same specification with the used rapid fuse.
- Install dummy resistance in parallel with the load, to keep the sum of current flowing in the load and dummy resistance being over SSR minimum load current.
- When using random turn-on model for phase control, install noise filter between the load and the power of the load.
- Do not use near the equipment which generates strong magnetic force or high frequency noise.
- This unit may be used in the following environments.
  - Indoors (in the environment condition rated in 'Specifications')
  - Altitude max. 2,000 m
  - Pollution degree 2
  - Installation category II

Model												
Model	Rated input voltage	Rated load current	Rated load voltage	Connections	Function							
SRS1-A1202	4 - 24 VDC≐	2 A	24 - 240 VAC~		Zero cross turn-on							
SRS1-A1202R					Random turn-on							
SRS1-A1203		3 A			Zero cross turn-on							
SRS1-A1203R					Random turn-on							
SRS1-A1205		5 A			Zero cross turn-on							
SRS1-A1205R					Random turn-on							
SRS1-A1D101	4 - 24 VDC≐	1 A	5 - 100 VDC≐		Zero cross turn-on							
SRS1-A1D102		2 A			Random turn-on							
SRS1-A1D201		1 A			5 - 200 VDC≐	Random turn-on						
SRS1-A1X201	4 - 30 VDC≐	1 A	5 - 240 VAC~/5 - 200 VDC≐		Zero cross turn-on							
SRS1-B1202					2 A	90 - 240 VAC~		Random turn-on				
SRS1-B1202R-2									Zero cross turn-on			
SRS1-B1203-1								3 A	90 - 240 VAC~		Random turn-on	
SRS1-B1203R-1												Zero cross turn-on
SRS1-B1205-1											5 A	90 - 240 VAC~
SRS1-B1205R-1		Zero cross turn-on										
SRS1-C1202-2	4 - 30 VDC≐	2 A	90 - 240 VAC~		Zero cross turn-on							
SRS1-C1202R-2						Random turn-on						
SRS1-C1203-1					3 A	90 - 240 VAC~		Zero cross turn-on				
SRS1-C1203R-1									Random turn-on			
SRS1-C1205-1								5 A	90 - 240 VAC~		Zero cross turn-on	
SRS1-C1205R-1						Random turn-on						
SRS1-C1D102-1	4 - 24 VDC≐	2 A	5 - 100 VDC≐		Zero cross turn-on							
SRS1-C1X201-1		1 A			5 - 240 VAC~/5 - 200 VDC≐	Random turn-on						

Applied socket			
Model	SRS1-A	SRS1-B	SRS1-C
Socket	SK-G05	LY2	MY4
Type	Autonics sockets, Sold separately	General	General

## Dimensions

• Unit: mm, For the detailed drawings, follow the Autonics website.

A Input indicator (red)

### SRS1-A

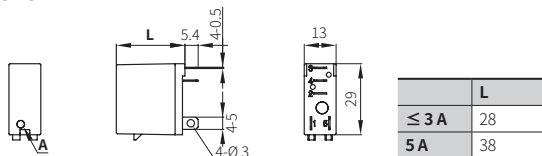

### SRS1-B

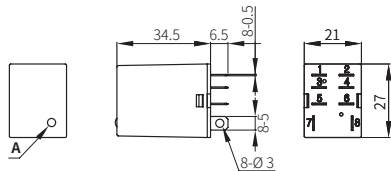

### SRS1-C

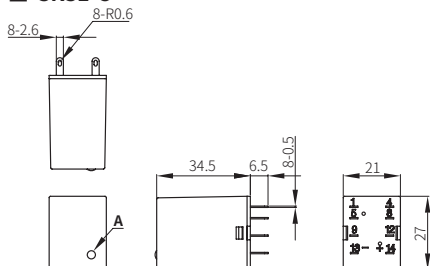

## Specifications

### Input

Model	SRS1-A	SRS1-B	SRS1-C120	SRS1-C1
Rated input voltage range	4 - 24 VDC≐	4 - 30 VDC≐	4 - 30 VDC≐	4 - 24 VDC≐
Allowable input voltage range	4 - 26.4 VDC≐	4 - 32 VDC≐	4 - 32 VDC≐	4 - 26.4 VDC≐
Max. input current	15 mA (Random turn-on)	13 mA (Random turn-on)	13 mA (Random turn-on)	15 mA
Operating voltage	≥ 4 VDC≐			
Releasing voltage	≤ 1 VDC≐			

### Output (AC load)

Model	SRS1-A			SRS1-B / SRS1-C		
	1202(R)	1203(R)	1205(R)	1202(R)-2	1203(R)-1	1205(R)-1
Rated input load range	24 - 240 VACrms~ (50 / 60 Hz)			90 - 240 VACrms~ (50 / 60 Hz)		
Allowable input load range	24 - 264 VACrms~ (50 / 60 Hz)			90 - 264 VACrms~ (50 / 60 Hz)		
Rated load current	2 Arms	3 Arms	5 Arms	2 Arms	3 Arms	5 Arms
Resistive load (AC-51 <sup>01)</sup>	2 Arms	3 Arms	5 Arms	2 Arms	3 Arms	5 Arms
Min. load current	0.15 Arms	0.2 Arms		0.15 Arms		
Max. 1 cycle surge current (60 Hz)	126 A	250 A		126 A		250 A
Max. non-repetitive surge current (I <sup>2</sup> t, t = 8.3 ms)	65 A <sup>2</sup> s	400 A <sup>2</sup> s		65 A <sup>2</sup> s		220 A <sup>2</sup> s
Peak voltage (non-repetitive)	600 V					
Leakage current (Ta = 25 °C)	≤ 2 mArms (240 VAC~ / 50/60 Hz)					
Output ON voltage drop [Vpk] (Max. load current)	≤ 1.6 V					
Static off state dv/dt	500 V/μs					
Operating time	Zero cross turn-on: ≤ 0.5 cycle of load power + 1 ms Random turn-on: ≤ 1 ms					
Releasing time	≤ 0.5 cycle of load power + 1 ms					

01) AC-51 is utilization category at IEC60947-4-3.

### Output (DC load)

Model	SRS1-A1D101	SRS1-A1D102	SRS1-A1D201	SRS1-C1D102-1
Rated input load range	5 - 100 VDC≐		5 - 200 VDC≐	5 - 100 VDC≐
Allowable input load range	3 - 120 VDC≐		3 - 220 VDC≐	3 - 120 VDC≐
Rated load current	1 Adc	2 Adc	1 Adc	2 Adc
Resistive load (AC-51 <sup>01)</sup>	1 Adc	2 Adc	1 Adc	2 Adc
Min. load current	10 mA			
Max. surge current (t=10 ms)	5 A	10 A	4 A	10 A
Leakage current (Ta = 25 °C)	≤ 100 μA			
Output ON voltage drop [Vpk] (Max. load current)	≤ 1.1 V			
Static off state dv/dt	500 V/μs			
Operating time	≤ 1 ms	≤ 2 ms	≤ 1 ms	≤ 1 ms
Releasing time	≤ 1 ms			

01) AC-51 is utilization category at IEC60947-4-3.

### Output (AC / DC load)

Model	SRS1-A1X201	SRS1-C1X201-1
Rated input load range	5 - 240 VACrms~ (50 / 60 Hz) / 5 - 200 VDC≐	
Allowable input load range	3 - 264 VACrms~ (50 / 60 Hz) / 3 - 220 VDC≐	
Rated load current	1 Arms / 1 Adc	
Resistive load (AC-51 <sup>01)</sup>	1 Arms / 1 Adc	
Min. load current	10 mA	
Max. surge current (t=10 ms)	4 A	
Leakage current (Ta = 25 °C)	≤ 2 mArms	≤ 2 mArms (240 VAC~ / 50 / 60 Hz)
Output ON voltage drop [Vpk] (Max. load current)	≤ 2.2 V	
Static off state dv/dt	500 V/μs	-
Operating time	≤ 2 ms	
Releasing time	≤ 1 ms	

01) AC-51 is utilization category at IEC60947-4-3.

### General specifications

Dielectric strength (Vrms)	Between the charging part and the case: 2500 VAC~ / 50/60 Hz for 1 min
Insulation resistance	≥ 100 MΩ (500 VDC≐ megger)
Indicator	Input indicator (red)
Ambient temperature <sup>01)</sup>	-20 ~ 80 °C (SRS1-A: -20 ~ 70 °C), storage: -30 ~ 100 °C (no freezing or no condensation)
Ambient humidity	45 ~ 85 %RH, storage: 45 ~ 85 %RH (no freezing or condensation)
Protection	According to protection of the using socket
Approval	CE, RoHS, REACH

01) Refer to the 'SSR Derating Curve' because the capacity of the rated load current is differ depending on the ambient temperature.

	SRS1-A	SRS1-B	SRS1-C
Weight (packaged) <sup>01)</sup>	≤ 3 A: ≈ 17 g (≈ 270 g), 5 A: ≈ 28 g (≈ 380 g)	≈ 30 g (≈ 400 g)	≈ 30 g (≈ 400 g)

01) The weight is per 10 units with packing and the weight of parenthesis is per 1

## Varistor / Load Specifications

- Must use a Varistor. Refer to the table for varistors and load capacities.

Models	Varistor	RESISTIVE LOAD
SRS1-A1202(R)	470 V, 0.6 W	240 VAC~ 2 A
SRS1-A1203(R)	470 V, 0.6 W	240 VAC~ 3 A
SRS1-A1205(R)	470 V, 0.6 W	240 VAC~ 5 A
SRS1-A1D101	270 V, 0.6 W	100 VDC≐ 1 A
SRS1-A1D102	270 V, 0.6 W	100 VDC≐ 2 A
SRS1-A1D201	470 V, 0.6 W	200 VDC≐ 1 A
SRS1-A1X201	470 V, 0.6 W	240 VAC~ 1 A / 200 VDC≐ 1 A
SRS1-B1202(R)-2	470 V, 0.6 W	240 VAC~ 2 A
SRS1-B1203(R)-1	470 V, 0.6 W	240 VAC~ 3 A
SRS1-B1205(R)-1	470 V, 0.6 W	240 VAC~ 5 A
SRS1-C1202(R)-2	470 V, 0.6 W	240 VAC~ 2 A
SRS1-C1203(R)-1	470 V, 0.6 W	240 VAC~ 3 A
SRS1-C1205(R)-1	470 V, 0.6 W	240 VAC~ 5 A
SRS1-C1D102-1	270 V, 0.6 W	100 VDC≐ 2 A
SRS1-C1X201-1	470 V, 0.6 W	240 VAC~ 1 A / 200 VDC≐ 1 A

## Cautions during Installation

### Caution High Temperature

While supplying power to the load or right after turning off the power of the load, do not touch the body and heat sink. Failure to follow this instruction may result in burn due to high temperature of the surface.

### ■ Spacing

- When installing multiple SSRs, be sure to keep space between SSRs for heat radiation.
- When installing SSRs horizontally (input part and output part on the same height), be sure to supply less than 50 % of the rated load current.

## SSR Derating Curve

- Be aware that the ambient temperature and the derating curve is different by the rated input voltage when using the product.
- ⚠ Since the effectiveness of the heat radiation is decreased when SSRs are installed closely, be sure to supply less than 50 % of the rated load current.
- SSR derating curves obtained approval from the UL certification authority.

### ■ AC load

- SRS1-A

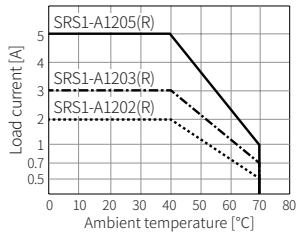

- SRS1-B

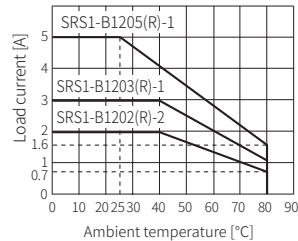

- SRS1-C

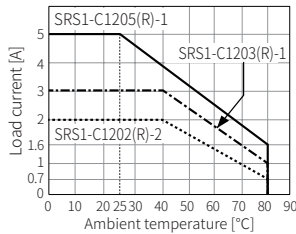

### ■ DC, AC / DC load

- SRS1-A

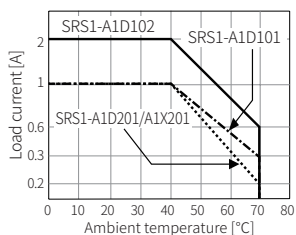

- SRS1-C

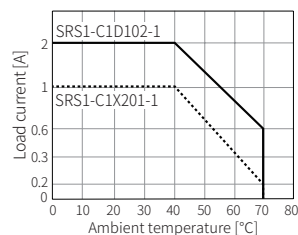

## Sold Separately: SK-G05 (for SRS1-A)

- Unit: mm, For the detailed drawings, follow the Autonics website.
- Protection: IP10

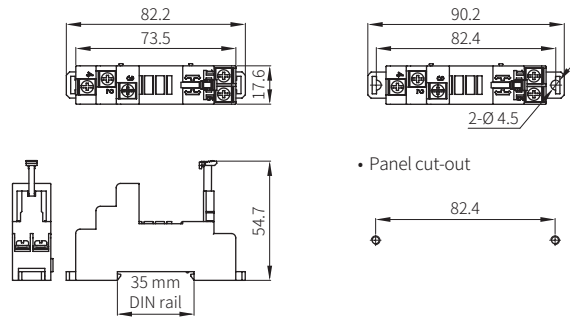

## Example of Connections

For AC load models, when connecting the CAP (capacitor), it is appropriate for EMC. (1 μF / 250 VAC~)

### ■ AC load

- SRS1-A

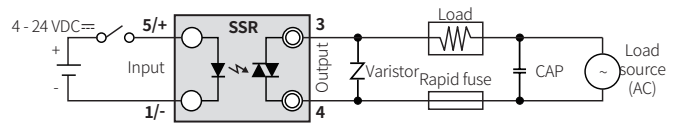

- SRS1-B

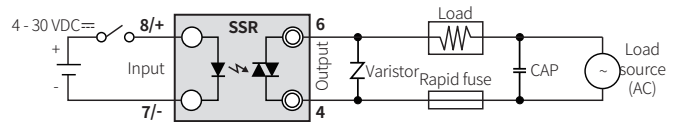

- SRS1-C

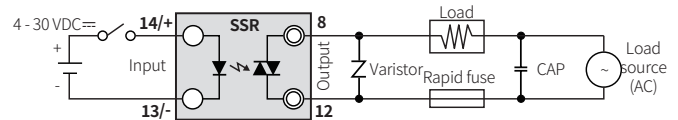

### ■ DC load

- SRS1-A

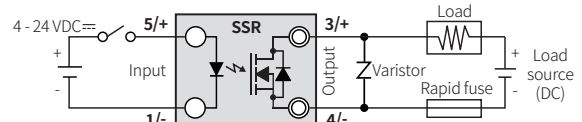

- SRS1-C

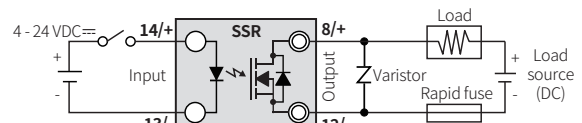

### ■ AC / DC load

- SRS1-A

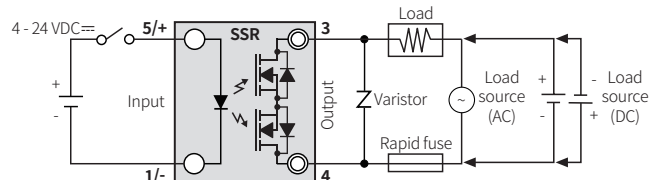

- SRS1-C

