

# Two-Degree-of-Freedom PID Temperature Controllers



## TN Series PRODUCT MANUAL

**For your safety, read and follow the considerations written in the instruction manual, other manuals and Autonics website.**

The specifications, dimensions, etc are subject to change without notice for product improvement. Some models may be discontinued without notice.

### Features

- 2-DOF PID algorithm optimized for various control environments
- 50 ms high-speed sampling and  $\pm 0.2\%$  display accuracy
- Program control and fixed control models available
  - Up to 10 patterns X 20 steps program setting (program control model)
  - Timer function for preset operation (fixed control model)
- Simultaneous heating/cooling and automatic/manual control function
- Control functions: Group PID, Zone PID, Anti Reset Windup (ARW)
- Control status monitoring of up to 10 events
- RS485 communication output model available
  - Communication protocols: Modbus RTU/ASCII, PLC ladderless, Sync-Master
  - Communication speed: up to 115,200bps
- Heater burnout alarm function (CT input)
- Parameter setting via PC
  - Comprehensive Device Management Software (DAQMaster) provided
  - Communication converter connection with front loader port (TNH, TNL only)
- Shortcut key setting with front user key button [U]
- Easy maintenance with detachable terminal blocks

### Safety Considerations

- Observe all 'Safety Considerations' for safe and proper operation to avoid hazards.
- **⚠** symbol indicates caution due to special circumstances in which hazards may occur.

**⚠ Warning** Failure to follow instructions may result in serious injury or death

- 01. Fail-safe device must be installed when using the unit with machinery that may cause serious injury or substantial economic loss.** (e.g. nuclear power control, medical equipment, ships, vehicles, railways, aircraft, combustion apparatus, safety equipment, crime/disaster prevention devices, etc.)  
Failure to follow this instruction may result in personal injury, economic loss or fire.
- 02. Do not use the unit in the place where flammable/explosive/corrosive gas, high humidity, direct sunlight, radiant heat, vibration, impact or salinity may be present.**  
Failure to follow this instruction may result in explosion or fire.
- 03. Install on a device panel to use.**  
Failure to follow this instruction may result in electric shock.
- 04. Do not connect, repair, or inspect the unit while connected to a power source.**  
Failure to follow this instruction may result in fire or electric shock.
- 05. Check 'Connections' before wiring.**  
Failure to follow this instruction may result in fire.
- 06. Do not disassemble or modify the unit.**  
Failure to follow this instruction may result in fire or electric shock.

**⚠ Caution** Failure to follow instructions may result in injury or product damage

- 01. When connecting the power input and relay output, use AWG 20 (0.50 mm<sup>2</sup>) cable or over, and tighten the terminal screw with a tightening torque of 0.74 to 0.90 N m.**  
**When connecting the sensor input and communication cable without dedicated cable, use AWG 28 to 16 cable and tighten the terminal screw with a tightening torque of 0.74 to 0.90 N m.**  
Failure to follow this instruction may result in fire or malfunction due to contact failure.
- 02. Use the unit within the rated specifications.**  
Failure to follow this instruction may result in fire or product damage
- 03. Use a dry cloth to clean the unit, and do not use water or organic solvent.**  
Failure to follow this instruction may result in fire or electric shock.
- 04. Keep the product away from metal chip, dust, and wire residue which flow into the unit.**  
Failure to follow this instruction may result in fire or product damage.

### Cautions during Use

- Follow instructions in 'Cautions during Use'. Otherwise, it may cause unexpected accidents.
- Check the polarity of the terminals before wiring the temperature sensor. For RTD temperature sensor, wire it as 3-wire type, using cables in same thickness and length. For thermocouple (TC) temperature sensor, use the designated compensation wire for extending wire.
- Keep away from high voltage lines or power lines to prevent inductive noise. In case installing power line and input signal line closely, use line filter or varistor at power line and shielded wire at input signal line. Do not use near the equipment which generates strong magnetic force or high frequency noise.
- Do not apply excessive power when connecting or disconnecting the connectors of the product.

- Install a power switch or circuit breaker in the easily accessible place for supplying or disconnecting the power.
- Do not use the unit for other purpose (e.g. voltmeter, ammeter), but temperature controller.
- When changing the input sensor, turn off the power first before changing. After changing the input sensor, modify the value of the corresponding parameter.
- Do not overlapping communication line and power line. Use twisted pair wire for communication line and connect ferrite bead at each end of line to reduce the effect of external noise.
- Make a required space around the unit for radiation of heat. For accurate temperature measurement, warm up the unit over 20 min after turning on the power.
- Make sure that power supply voltage reaches to the rated voltage within 2 sec after supplying power.
- Do not wire to terminals which are not used.
- This unit may be used in the following environments.
  - Indoors (in the environment condition rated in "Specifications")
  - Altitude Max. 2,000 m
  - Pollution degree 2
  - Installation category II

## Ordering Information

This is only for reference, the actual product does not support all combinations. For selecting the specified model, follow the Autonics website .

**T N ① - ② ③ ④ ⑤ ⑥ - ⑦ ⑧ - ⑨**

### ① Size

S: DIN W 48 × H 48 mm  
H: DIN W 48 × H 96 mm  
L: DIN W 96 × H 96 mm

### ② Control method

No mark: Fixed control  
P: Program control

### ③ Power supply

4: 100 - 240 VAC

### ④ Alarm outputs

2: Alarm 1 / 2  
4: Alarm 1 / 2 / 3 / 4  
6: Alarm 1 / 2 / 3 / 4 / 5 / 6

### ④ Control output 1

R: Relay  
S: SSR drive  
C: Current or SSR drive

### ⑥ Control output 2

R: Relay  
S: SSR drive  
C: Current or SSR drive

### ⑦ Communication

N: None  
R: RS485

### ⑧ Terminal type

S: Screw

### ⑨ Option input/output

No.	Digital input	CT input	Transmission output
006	0	1	0
008	2	1	0
009	3	1	0
014	3	2	0
026	0	1	1
031	0	2	1
035	6	2	1

## Manual

For proper use of the product, refer to the manuals and be sure to follow the safety considerations in the manuals. Download the manuals from the Autonics website.

## Software

Download the installation file and the manuals from the Autonics website.

### ■ DAQMaster

DAQMaster is comprehensive device management program. It is available for parameter setting, monitoring.

## Product Components

- Product (+ bracket)
- Instruction manual

## Sold Separately

- Front cover: FSA / FHA / FLA-COVER
- Current transformer (CT)
- Terminal protection cover: RSA / RMA / RHA / RLA-COVER
- Communication Converter: SCM-USP / SCM-38I / SCM-US48I / SCM-WF48

## Specifications

<b>Power supply</b>	100 - 240 VAC~, 50/60 Hz	
<b>Permissible voltage range</b>	90 to 110 % of rated voltage	
<b>Power consumption</b>	≤ 8 VA	
<b>Display type</b>	11 segment, LCD type (operating value display part: 7 segment)	
<b>Sampling period</b>	50 / 100 / 250 ms (parameter)	
<b>Input specification</b>	Refer to "Input Type and Using Range"	
<b>Option input</b>	CT	<ul style="list-style-type: none"> <li>• 0.0-50.0 A (primary current measurement range)</li> <li>• CT ratio: 1/1,000</li> <li>• Measurement accuracy: ±5% F.S. ±1digit</li> </ul>
	Digital	<ul style="list-style-type: none"> <li>• Contact - ON: ≤ 2 kΩ, OFF: ≥ 90 kΩ</li> <li>• Non contact - residual voltage ≤ 1.0 V, leakage current ≤ 0.1 mA</li> <li>• Outflow current: ≈ 0.5 mA per input</li> </ul>
<b>Control output</b>	Relay	250 VAC~ 3A 1a
	SSR	12 VDC= ±2 V, ≤ 20 mA
	Current	DC 0 - 20 mA or DC 4 - 20 mA (parameter), Load resistance: ≤ 500 Ω
<b>Option output</b>	Alarm	250 VAC~ 3A 1a
	Transmission	DC 4 - 20 mA (load resistance: ≤ 500 Ω, output accuracy: ±0.3% F.S.)
	Communication	RS485
<b>Control type</b>	Type	ON/OFF, P, PI, PD, PID
	Multi SV	≤ 4 SV
	Group PID	≤ 8 group
	Zone PID	4 zones
<b>Program control</b>	ARW (Anti Reset Windup)	50 to 200 %
	Program	≤ 10 patterns
	Step	≤ 200 steps (1 pattern: ≤ 20 steps)
<b>Setting type</b>	Setting type	Time setting
	<b>Hysteresis</b>	<ul style="list-style-type: none"> <li>• Thermocouple, RTD: 1 to 100 (0.1 to 100.0) °C/°F</li> <li>• Analog: 1 to 100 digit</li> </ul>
<b>Proportional band (P)</b>	0.1 to 999.9 °C (0.1 to 999.9%)	
<b>Integral time (I)</b>	0 to 9,999 sec	
<b>Derivative time (D)</b>	0 to 9,999 sec	
<b>Control cycle (T)</b>	<ul style="list-style-type: none"> <li>• Relay / SSR output: 0.1 to 120.0 sec</li> <li>• Selectable current or SSR drive output: 1.0 to 120.0 sec</li> </ul>	
<b>Manual reset</b>	0.0 to 100.0%	
<b>Dielectric strength</b>	Between the charging part and the case: 3,000 VAC~ 50/60 Hz for 1 min	
<b>Vibration</b>	0.75 mm amplitude at frequency of 5 to 55 Hz in each X, Y, Z direction for 2 hours	
<b>Relay life cycle</b>	Mechanical	<ul style="list-style-type: none"> <li>• OUT1/2: ≥ 5,000,000 operations</li> <li>• AL1/2/3/4/5/6: ≥ 20,000,000 operations</li> </ul>
	Electrical	<ul style="list-style-type: none"> <li>• OUT1/2: ≥ 200,000 operations</li> <li>• AL1/2/3/4/5/6: ≥ 100,000 operations</li> </ul>
<b>Insulation resistance</b>	≥ 100 MΩ (500 VDC= megger)	
<b>Insulation type</b>	Double insulation or reinforced insulation (mark: □), dielectric strength between the measuring input part and the power part: 3 kV)	
<b>Noise immunity</b>	±2 kV square shaped noise by noise simulator (pulse width: 1 μs) R-phase, S-phase	
<b>Memory retention</b>	≈ 10 years (non-volatile semiconductor memory type)	
<b>Ambient temperature</b>	-10 to 50 °C, storage: -20 to 60 °C (no freezing or condensation)	
<b>Ambient humidity</b>	35 to 85%RH	
<b>Protection structure</b>	IP65 (Front panel, IEC standards)	
<b>Loader port</b>	<ul style="list-style-type: none"> <li>• TNS: top side</li> <li>• TNH, TNL: front side</li> </ul>	
<b>Unit weight (packaged)</b>	<ul style="list-style-type: none"> <li>• TNS: ≈ 128 g (≈ 156 g)</li> <li>• TNH: ≈ 184 g (≈ 286 g)</li> <li>• TNL: ≈ 301 g (≈ 443 g)</li> </ul>	
<b>Certification</b>	CE UK e SA US DE ENEC	

## Communication Interface

### ■ RS485

<b>Comm. protocol</b>	Modbus RTU/ASCII, Sync-Master, PLC ladderless
<b>Connection type</b>	RS-485, RS-422A
<b>Application standard</b>	EIA RS485 compliance with
<b>Maximum connection</b>	32 units (address: 01 to 99)
<b>Synchronous method</b>	Asynchronous
<b>Comm. Method</b>	Two-wire half duplex
<b>Comm. effective range</b>	≤ 800 m
<b>Comm. speed</b>	≤ 115,200 bps
<b>Response time</b>	5 to 99 ms (default: 20 ms)
<b>Start bit</b>	1 bit (fixed)
<b>Data bit</b>	8 bit (fixed)
<b>Parity bit</b>	None (default), Odd, Even
<b>Stop bit</b>	1 bit, 2 bit (default)
<b>EEPROM life cycle</b>	≈ 1,000,000 operations (Erase / Write)

• 1 character of ModBus RTU is fixed at 11 bit.

## Input Type and Using Range

The setting range of some parameters is limited when using the decimal point display.

Input type	Decimal point	Display	Using range (°C)	Using range (°F)	
Thermo-couple	K (CA)	1	ℓ ℓ RH	-200 to 1,350	-328 to 2,462
		0.1	ℓ ℓ RL	-199.9 to 999.9	-199.9 to 999.9
	J (IC)	1	J J ℓ H	-200 to 800	-328 to 1,472
		0.1	J J ℓ L	-199.9 to 800.0	-199.9 to 999.9
	E (CR)	1	ℓ ℓ RH	-200 to 800	-328 to 1,472
		0.1	ℓ ℓ RL	-199.9 to 800.0	-199.9 to 999.9
	T (CC)	1	ℓ ℓ ℓ H	-200 to 400	-328 to 752
		0.1	ℓ ℓ ℓ L	-199.9 to 400.0	-199.9 to 752.0
	B (PR)	1	b PR	0 to 1,800	32 to 3,272
	R (PR)	1	R PR	0 to 1,750	32 to 3,182
	S (PR)	1	S PR	0 to 1,750	32 to 3,182
	N (NN)	1	N NN	-200 to 1,300	-328 to 2,372
	C (TT) <sup>01)</sup>	1	ℓ ℓ ℓ	0 to 2,300	32 to 4,172
	G (TT) <sup>02)</sup>	1	G ℓ ℓ	0 to 2,300	32 to 4,172
	L (IC)	1	L ℓ ℓ H	-200 to 900	-328 to 1,652
		0.1	L ℓ ℓ L	-199.9 to 900.0	-199.9 to 999.9
U (CC)	1	U ℓ ℓ H	-200 to 400	-328 to 752	
	0.1	U ℓ ℓ L	-199.9 to 400.0	-199.9 to 752.0	
Platinel II	1	P L I I	0 to 1,390	32 to 2,534	
L (RUS)	1	ℓ RH	-200 to 800	-328 to 1,472	
	0.1	ℓ RL	-199.9 to 800.0	-199.9 to 999.9	
RTD	Cu50 Ω	0.1	ℓ U 5	-199.9 to 200.0	-199.9 to 392.0
		1	ℓ U 10	-199.9 to 200.0	-199.9 to 392.0
	JPt100 Ω	1	J P ℓ H	-200 to 650	-328 to 1,202
		0.1	J P ℓ L	-199.9 to 650.0	-199.9 to 999.9
	DPT50 Ω	0.1	d P ℓ 5	-199.9 to 600.0	-199.9 to 999.9
		1	d P ℓ H	-200 to 650	-328 to 1,202
DPT100 Ω	0.1	d P ℓ L	-199.9 to 650.0	-199.9 to 999.9	
	1	d P ℓ H	-200 to 650	-328 to 1,202	
Nickel120 Ω	1	N I 12	-80 to 260	-112 to 500	
Analog	0 to 10 V	-	R V 1	0 to 10 V	
	0 to 5 V	-	R V 2	0 to 5 V	
	1 to 5 V	-	R V 3	1 to 5 V	
	0 to 100 mV	-	R M V 1	0 to 100 mV	
	0 to 20 mA	-	R M A 1	0 to 20 mA	
	4 to 20 mA	-	R M A 2	4 to 20 mA	

• Permissible line resistance per line: ≤ 5 Ω

01) C (TT): Same as existing W5 (TT) type sensor

02) G (TT): Same as existing W (TT) type sensor

### Display accuracy

Input type	Using temperature	Display accuracy
Thermo-couple RTD	At room temperature (23°C ± 5°C)	(PV ± 0.2% or ± 1°C higher one) ± 1-digit • Thermocouple K, J, T, N, E below -100°C and L, U, PLII, RTD Cu50 Ω, DPT50 Ω: (PV ± 0.3% or ± 2°C higher one) ± 1-digit • Thermocouple C, G and R, S below 200°C: (PV ± 0.3% or ± 3°C higher one) ± 1-digit • Thermocouple B below 400°C: There is no accuracy standards
	Out of room temperature range	(PV ± 0.5% or ± 2°C higher one) ± 1-digit • RTD Cu50 Ω, DPT50 Ω: (PV ± 0.5% or ± 3°C higher one) ± 1-digit • Thermocouple R, S, B, C, G: (PV ± 0.5% or ± 5°C higher one) ± 1-digit • Other sensors: ≤ ± 5°C (≤ -100°C)
Analog	At room temperature (23°C ± 5°C)	± 0.2% F.S. ± 1-digit
	Out of room temperature range	± 0.5% F.S. ± 1-digit

## Unit Descriptions

• Below is based on TNL Series.

• The shape and function of each part may be different depending on the series, and it is possible to check the additional information in the user manual.

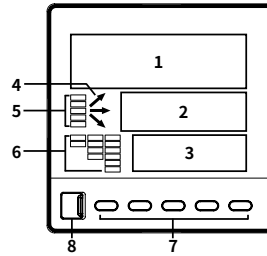

### 1. PV display part (White)

- RUN mode: Displays PV (Present value) and unit.
- Setting mode: Displays parameter name

### 2. SV display part (Green)

- RUN mode: Displays SV (Setting value) and unit.
- Setting mode: Displays parameter setting value.

### 3. Operating value display part (Yellow)

- RUN mode: Displays selected value among MV (Manipulated output value), P/S, TM, CT with unit.

### 4. Temperature control indicator

- Fixed control: Relative PV value status display based on SV  
PV > SV (↗), PV = SV (→), PV < SV (↘)
- Program control: Displays temperature control status of up (↗), hold (→), down (↘).

### 5. Operation status indicator

Display	Name	Description
LOCK	Lock	Turns ON during key lock status.
PROG	Program	Turns ON during program control.
WAIT	Wait	Turns ON during waiting status.
HBA1/2	Heater break alarm	Turns ON when the heater break alarm output is ON.

### 7. Input key

Display	Name
[U]	User key
[M]	Mode key
[◀], [▼], [▲]	Setting value control key

### 8. PC loader port

For connecting communication converter (SCM-USP).

### 6. Output status indicator

Display	Name	Description
OUT1/2	Control output	Turns ON when the control output is ON
AT	Auto tuning	Flashes during auto tuning every 1 sec
MAN	Manual control	Turns ON during manual control mode
STOP	Control output stop	Turns ON during control output stop mode
HOLD	Program control hold	Turns ON when program control is hold status
ALL1 to 6	Alarm output	Turns ON when the alarm output is ON

## Errors

Display	Input	Description	Output	Troubleshooting
OPEN	Temperature sensor	Flashes at 0.5 sec interval when input sensor is disconnected or sensor is not connected.	'Sensor error, MV' parameter setting value	Check input sensor status.
	Analog	Flashes at 0.5 sec interval when input is over F.S. ± 10%.	'Sensor error, MV' parameter setting value	Check analog input status.
HHHH	Temperature sensor	Flashes at 0.5 sec interval if the input value is above the input range. <sup>01)</sup>	Heating: 0%, Cooling: 100%	When input is within the rated input range, this display disappears.
	Analog	Flashes at 0.5 sec interval if the input value is over 5 to 10% of high limit or low limit value.	Normal output	
LLLL	Temperature sensor	Flashes at 0.5 sec interval if the input value is below the input range. <sup>01)</sup>	Heating: 100%, Cooling: 0%	When input is within the rated input range, this display disappears.
	Analog	Flashes at 0.5 sec interval if the input value is over 5 to 10% of low limit or high limit value.	Normal output	
ERR	-	Flashes at 0.5 sec interval if there is error for setting and it returns to the error-before screen.	-	Check setting method.
EMRE	-	Flashes twice and stops operation at the start of operation if the timer operation related parameter setting is not completed.	'STOP, MV' parameter setting value	Set the timer operation related parameters.
PEHE	-	Flashes twice and stops operation at the start of operation if the program operation related parameter setting is not completed.	'STOP, MV' parameter setting value	Set the program operation related parameters.
ER□□	-	Flashes twice the address of failed Slave when using Sync communication or PLC setting copy function.	-	Check the failed slave connection status and communication settings.

01) Be careful that when HHHH / LLLL error occurs, the control output may occur by recognizing the maximum or minimum input depending on the control type.

## Dimensions

- Unit: mm, For the detailed drawings, follow the Autonics website.
- Below is based on TNS Series.

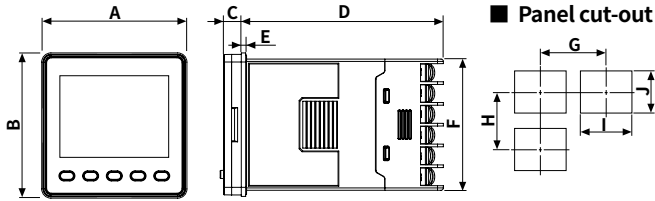

	Body						Panel cut-out			
	A	B	C	D	E	F	G	H	I	J
TNS	49	49	6	69	1.5	44.8	≥ 65	≥ 65	45 <sup>+0.6</sup> <sub>0</sub>	45 <sup>+0.6</sup> <sub>0</sub>
TNH	49	97	6	69	1.5	91.5	≥ 65	≥ 115	45 <sup>+0.6</sup> <sub>0</sub>	92 <sup>+0.8</sup> <sub>0</sub>
TNL	97	97	6	69	1.5	91.5	≥ 115	≥ 115	92 <sup>+0.8</sup> <sub>0</sub>	92 <sup>+0.8</sup> <sub>0</sub>

## Bracket

### TNS

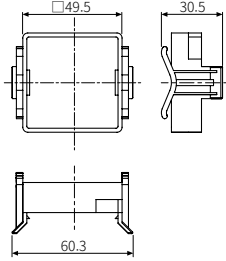

### Other series

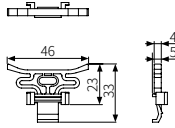

## Installation Method

### TNS

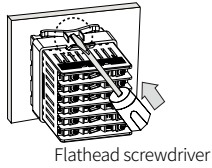

Flathead screwdriver

### Other series

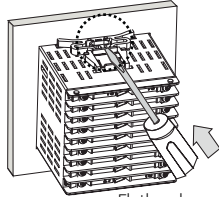

Flathead screwdriver

Insert the unit into a panel, fasten the bracket by pushing with tools with a flathead screwdriver.

## Connections

- Digital input is not electrically insulated from internal circuits, so it should be insulated when connecting other circuits.

### TNS

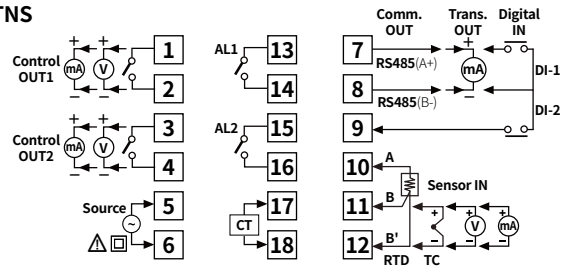

### TNH

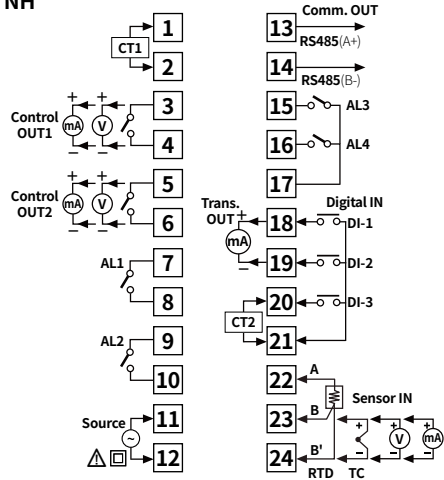

### TNL

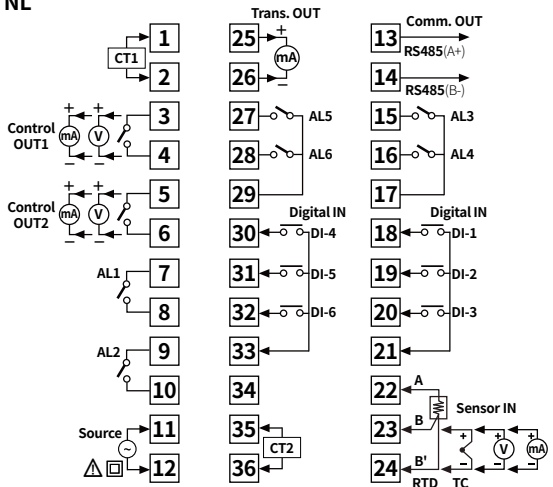

## Crimp Terminal Specifications

- Unit: mm, Use the crimp terminal of follow shape.

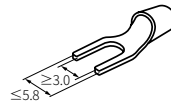

Fork crimp terminal

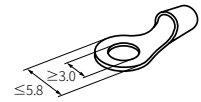

Round crimp terminal

## Initial Display When Power is ON

When power is supplied, after all display will flash for 1 sec, model name is displayed sequentially. After input sensor type will flash twice, enter into RUN mode.

Display part	1. Model	2. Model	3. Input specification	4. RUN mode
PV	ENS.P	R5	TYPE	OPEN
SV	42RR	006	KCRH	0

## Mode Setting

RUN	Auto before entering to mode (when using password) →	<b>Password input</b>	<table border="1"> <thead> <tr> <th>Password</th> <th>Key input</th> <th>Entering mode</th> </tr> </thead> <tbody> <tr> <td>Pass</td> <td>Auto</td> <td>Selected mode</td> </tr> <tr> <td>Fail</td> <td>[◀], [▲], [▼] [MODE]</td> <td>Password input Run mode</td> </tr> </tbody> </table>	Password	Key input	Entering mode	Pass	Auto	Selected mode	Fail	[◀], [▲], [▼] [MODE]	Password input Run mode	
	Password	Key input	Entering mode										
	Pass	Auto	Selected mode										
	Fail	[◀], [▲], [▼] [MODE]	Password input Run mode										
	[◀], [▲], [▼] (in manual control) →	<b>MV setting</b>	Move digits: [◀] Change value: [▲], [▼] Save: When chage values Return: [MODE] or no key input over 3 sec	RUN									
	[◀], [▲], [▼] (in auto control) →	<b>SV setting</b>	Move digits: [◀] Change value: [▲], [▼] Save and Return: [MODE] or no key input over 3 sec										
	[▼] + [▲] 3 sec →	<b>Control output run/stop</b>	Auto										
	[M] + [▲] →	<b>Operating value display part (MV / P/S / TM / CT) setting</b>	Auto										
	[U] + [◀] / [▼] / [▲] 2 sec →	<b>Shortcut key 1/2/3</b>	Auto										
	[◀] + [▼] 3 sec →	<b>Key lock ON/OFF</b>	Auto										
[M] 2 sec →	<b>Parameter group</b>	[◀] 2 sec											
[U] 2 sec →	<b>U key enter parameter group</b>	[◀] 2 sec											
[◀] + [▲] + [▼] 5 sec →	<b>Parameter reset</b>	Refer to 'Parameter Reset'											

\* TNS series does not support 'MV setting', 'Operation value display part setting' mode. For the details, refer to the user manual.

## Parameter Reset

01. Press the [◀] + [▲] + [▼] keys for over 5 sec. in run mode, INIT turns ON.
02. Change the setting value as YES by pressing the [▲], [▼] keys.
03. Press the [M] key to reset all parameter values as default and to return to run mode.

## Sold Separately: Front Cover

• Unit: mm

### ■ TNS: FSA-COVER

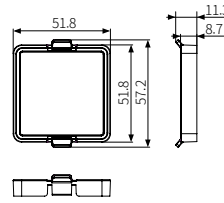

### ■ TNH: FHA-COVER

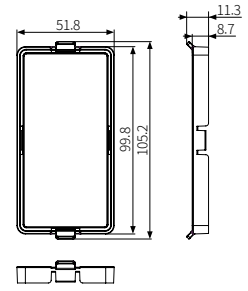

### ■ TNL: FLA-COVER

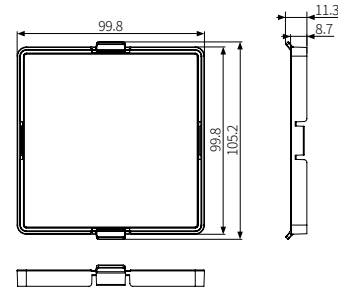

## Sold Separately: Terminal Protection Cover

• Unit: mm

### RSA-COVER: DIN W48 × H48

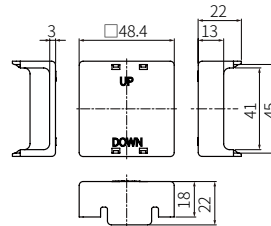

### RMA-COVER: DIN W72 × H72

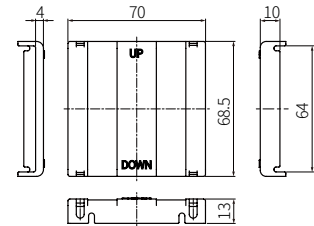

### RHA-COVER: DIN W48 × H96

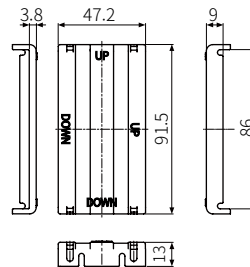

### RLA-COVER: DIN W96 × H96

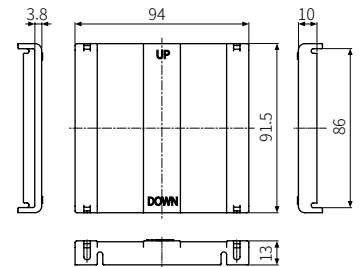

## Sold Separately: Current Transformer (CT)

- Unit: mm
- The current for above CTs is 50A same but inner hole sizes are different. Please use this for your environment.
- Do not supply primary current in case that CT output is open. High voltage will be generated in CT output.

### CSTC-E80LN

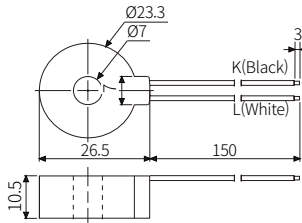

- Max. load current: 80A (50/60Hz)
- Current ratio: 1/1000
- Wire wounded resistance:  $31\Omega \pm 10\%$

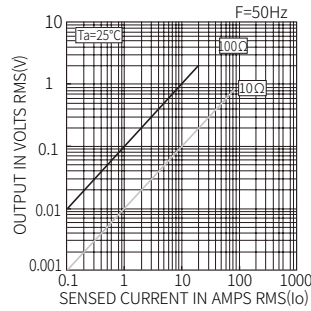

### CSTC-E200LN

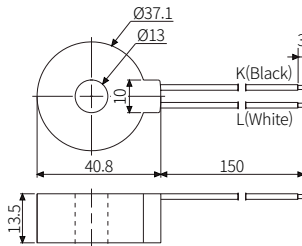

- Max. load current: 200A (50/60Hz)
- Current ratio: 1/1000
- Wire wounded resistance:  $20\Omega \pm 10\%$

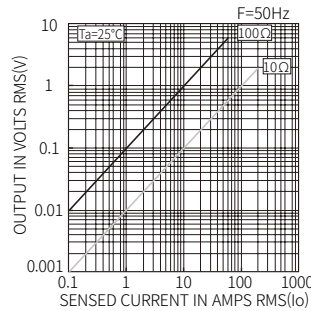

### CSTS-E80PP

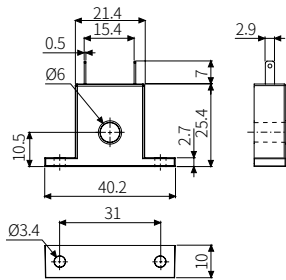

- Max. load current: 80A (50/60Hz)
- Current ratio: 1/1000
- Wire wounded resistance  $31\Omega \pm 10\%$

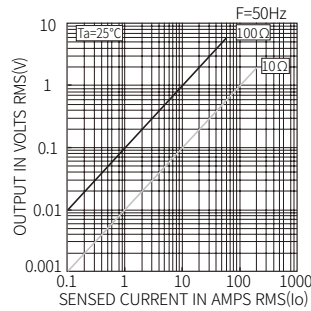

## Segment Table

The segments displayed on the product indicate the following meanings. It may differ depending on the product.

7 Segment	11 Segment	12 Segment	16 Segment
0	0	0	0
1	1	1	1
2	2	2	2
3	3	3	3
4	4	4	4
5	5	5	5
6	6	6	6
7	7	7	7
8	8	8	8
9	9	9	9
A	A	A	A
b	B	b	B
c	C	c	C
d	D	d	D
E	E	E	E
F	F	F	F
G	G	G	G
H	H	H	H
I	I	I	I
J	J	J	J
K	K	K	K
L	L	L	L
M	M	M	M
N	N	N	N
O	O	O	O
P	P	P	P
Q	Q	Q	Q
R	R	R	R
S	S	S	S
T	T	T	T
U	U	U	U
V	V	V	V
W	W	W	W
X	X	X	X
Y	Y	Y	Y
Z	Z	Z	Z