

Non-Indicating Pressure Transmitters



TPS30 Series PRODUCT MANUAL

For your safety, read and follow the considerations written in the instruction manual, other manuals and Autonics website.

The specifications, dimensions, etc are subject to change without notice for product improvement. Some models may be discontinued without notice.

Features

- Robust build allows high or low pressure measurement in high and low temperature environments
 - : High pressure (0 to 60 MPa/0 to 600 bar), low pressure (0 to 2 MPa/0 to 20bar)
 - : Sealed gauge pressure (-0.1 to 2 MPa / -1 to 20 bar), absolute pressure (0 to 2 MPa / 0 to 20 bar), gauge pressure (0 to 60 MPa/0 to 600 bar)
 - : Temperature range (-40 to 125 °C) (may vary by model)
- Applicable in diverse settings including packaging machines, heavy machinery, factories, and shipbuilding
- Pressure measurement of any gas, liquid, or oil
- 316L, 630 stainless steel body for high corrosion resistance (except head component of head types)
- Compact size allows easy installation in tight or limited spaces
- 1 ms high-speed response rate
- Analog output: current (DC 4-20 mA), voltage (1-5 VDC=)
- Built-in reverse polarity protection circuit
- Various connector types: cable type, DIN43650-A connector type, DT04-3P connector type, M12 connector type, head type
- Available thread sizes: G3/8, G1/4, R1/2
- IP67 protection structure (IEC standard) (DIN43650-A connector type: IP65)

Safety Considerations

- Observe all 'Safety Considerations' for safe and proper operation to avoid hazards.
- ⚠ symbol indicates caution due to special circumstances in which hazards may occur.

⚠ Warning Failure to follow instructions may result in serious injury or death.

- 01. Fail-safe device must be installed when using the unit with machinery that may cause serious injury or substantial economic loss (eg nuclear power control, medical equipment, ships, vehicles, railways, aircraft, combustion apparatus, safety equipment, crime/disaster prevention devices, etc).**
Failure to follow this instruction may result in personal injury, economic loss or fire.
- 02. Do not use the unit in the place where flammable/explosive/corrosive gas, humidity, direct sunlight, radiant heat, vibration, impact, or salinity may be present.**
Failure to follow this instruction may result in explosion or fire.
- 03. Do not disassemble or modify the unit.**
Failure to follow this instruction may result in fire or electric shock.

⚠ Caution Failure to follow instructions may result in injury or product damage.

- 01. Do not apply beyond rated pressure.**
Failure to follow this instruction may result in product damage.
- 02. Use the unit within the rated specifications.**
Failure to follow this instruction may result in fire or product damage.
- 03. Fix the cable through the cable connection part and do not turn the cable of the unit.**
Failure to follow this instruction may result in product damage.
- 04. Keep the product away from metal chip, dust, and wire residue which flow into the unit.**
Failure to follow this instruction may result in fire or product damage.
- 05. Check 'Connections' before wiring.**
Failure to follow this instruction may result in explosion or fire.
- 06. This product is designed to detect the pressure of noncorrosive medium. Do not use for corrosive medium.**
Failure to follow this instruction may result in product damage.
- 07. Use a dry cloth to clean the unit, and do not use water or organic solvent.**
Failure to follow this instruction may result in fire or electric shock.

Cautions during Use

- Follow instructions in 'Cautions during Use'. Otherwise, it may cause unexpected accidents.
- Power supply should be insulated and limited voltage/current or Class 2, SELV power supply device.
- When installing the unit on pipe line, use the hexagon part of connections not to turn the unit with a pipe wrench. Do not use the unit with strong vibrations.
- Store the unit at the place without moisture, dust, and vibration.
- This product is not needed to take maintenance because there is no moving part. But it needs to take maintenance once a year as below instructions even though inside of pressure pipe is normally clean.
 - Check the broken status of outside.
 - Check the pressure slot, cleanliness inside, and corrosion state.
 - Short each terminal and check the insulation resistance between the case and power.
- When removing a sensor for maintenance, follow the below instructions.
 - Replace an O-ring which is used once.
 - Be sure that diaphragm part is not damaged.
- Switch or circuit breaker should be installed nearby users for convenient control.
- The unit cannot be repaired due to disassembled structure.
- The unit is fixed with bolt and nut at the both sides of case. Do not press excessive load ($\approx 300\text{kg/cm}^2$), or it may cause damage to the unit.
- This unit may be used in the following environments.
 - Indoor / Outdoor (in the environment condition rated in 'Specifications')
 - Altitude max 2,000m
 - Pollution degree 2
 - Installation category II

Ordering Information

This is only for reference, the actual product does not support all combinations. For selecting the specified model, follow the Autonics website .

TPS30 - ① ② ③ ④ ⑤ - ⑥ (⑦)

① Pressure type

G: Gauge pressure, Sealed gauge pressure⁰¹⁾
A: Absolute pressure

② Cable

1: Head type
2: DIN43650-A connector type
3: M12 connector type
4: DT04-3P connector type
5: cable type

③ Rated Pressure range⁰³⁾

	Gauge pressure	Absolute pressure
3	0 to 0.1 MPa	0 to 0.1 MPa
4	0 to 0.2 MPa	0 to 0.2 MPa
5	0 to 0.7 MPa	0 to 0.7 MPa
6	0 to 1 MPa	0 to 1 MPa
7	0 to 2 MPa	0 to 2 MPa
8	0 to 3.5 MPa	
9	0 to 5 MPa	
A	0 to 10 MPa	
B	0 to 20 MPa	
C	0 to 40 MPa	
D	0 to 50 MPa	
E	0 to 60 MPa	
Sealed gauge pressure		
F	-0.1 to 0 MPa	
G	-0.1 to 0.1 MPa	
H	-0.1 to 0.7 MPa	
J	-0.1 to 1 MPa	
K	-0.1 to 2 MPa	
Z	Others	

④ Output

V: Voltage (1 - 5 VDC \Rightarrow) output
A: Current (DC 4 - 20 mA) output

⑤ Pressure port

G8: G3/8 (PF) (EN837)
G4: G1/4 (PF) (EN837)
R2: R1/2 (PT) (DIN3852)
N4: NPT1/4 (DIN3852)
ZZ: Others (Option)⁰²⁾

⑥ M12 connector cable

00: none
2L: I type, 2 m
5L: I type, 5 m
5L: L type, 5 m

⑦ User pressure range⁰⁴⁾

Customized pressure range and unit

01) The pressure is sealed gauge pressure. The unit is sealed structure. It is based on atmospheric pressure 101.3 kPa (1.013 bar).

02) The option ports are sold separately. In case of large amount ordering, contact the Autonics for manufacturing the requested pressure port.

03) G1/4 is the standard pressure port of part number 8 to 9, A to E. For the other pressure ranges, G3/8, R1/2 are standard pressure ports.

04) The pressure range is set to customized pressure range. (select 'Z' at ③ Rated pressure range)

Product Components

- Product
- Instruction manual
- DIN connector × 1 (DIN43650-A connector type)

Sold Separately

- DT04-3P connector: CS-DT3P
- M12 Connector cable: C□D3-2 / C□D3-5

Connections

Connection type	Head type	DIN43650-A connector type	M12 connector type	DT04-3P connector type	Cable type
Pin type					Voltage: 3-wire Current: 2-wire
Voltage output	+	+	1	A	Brown
	-	-	⊖	C	Blue
	Vout	Vout	2	B	Black
Current output	N.C	-	3	-	-
	+	+	1	A	Brown
Current output	-	-	⊖	C	Blue
	N.C	Vout	2,3	B	-

• In case of head type, remove the top cover.

Inner Circuit

■ Voltage output

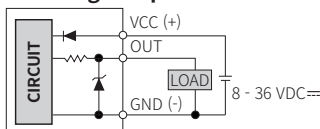

■ Current output

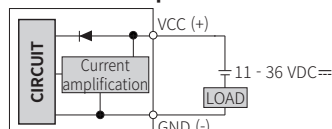

Dimensions

• Unit: mm, For the detailed drawings, follow the Autonics website.

■ Head type

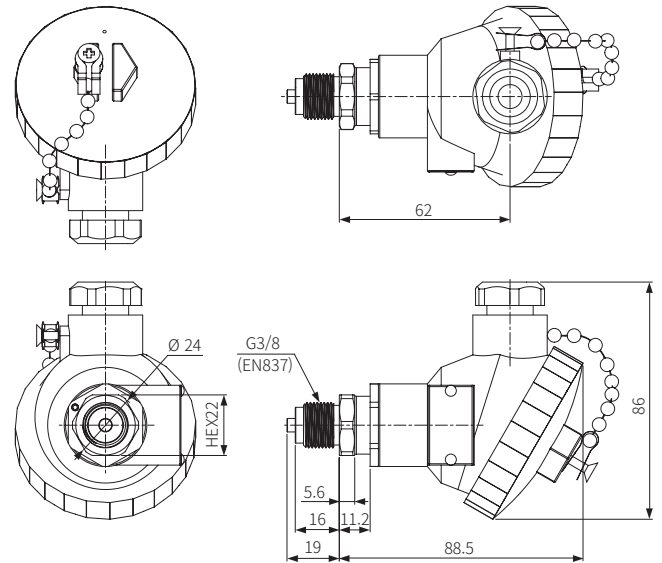

■ DIN43650-A connector type

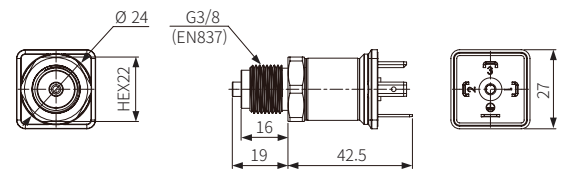
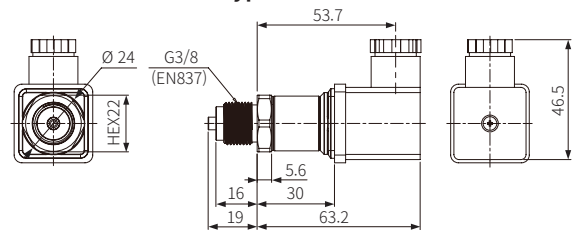

■ M12 connector type

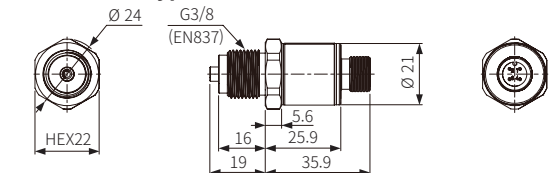

■ DT04-3P connector type

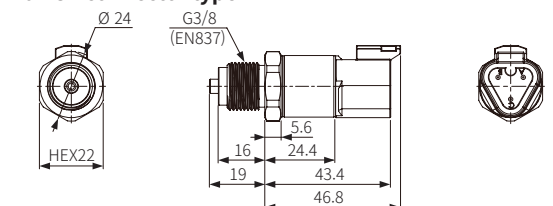

■ Cable type

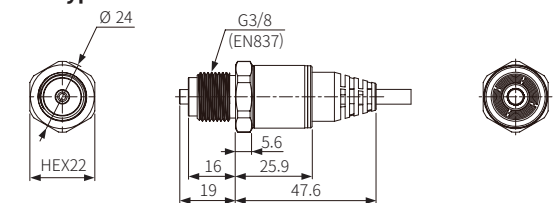

■ Pressure port

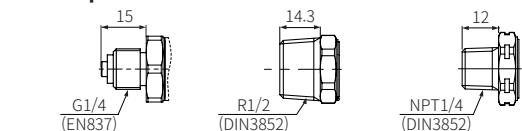

Specifications

■ Gauge pressure, Absolute pressure (unit: MPa)

Rated pressure range	0 to 0.1	0 to 0.2	0 to 0.7	0 to 1	0 to 2
Expanded analog output range	0 to 0.11	0 to 0.22	0 to 0.77	0 to 1.1	0 to 2.2
Max. pressure	0.6	0.6	3	3	3
Burst pressure	0.6	0.6	3	3	3
Compensation temperature	-10 to 80 °C				
Vibration	10 g, 20 to 2,000 Hz				
Shock	100 g / 6 ms				

■ Gauge pressure (unit: MPa)

Rated pressure range	0 to 3.5	0 to 5	0 to 10	0 to 20	0 to 40	0 to 50	0 to 60
Expanded analog output range	0 to 3.85	0 to 5.5	0 to 11	0 to 22	0 to 44	0 to 55	0 to 66
Max. pressure	10	10	20	50	80	120	120
Burst pressure	15	30	75	120	160	160	160
Compensation temperature	0 to 80 °C						
Temperature characteristic	-25 to 100 °C: ≤ ± 1.5 %F.S., -40 to 125 °C: ≤ ± 2.5 %F.S.						
Vibration	20 g, 20 to 2,000 Hz						
Shock	500 g / 1 ms						

■ Sealed gauge pressure (unit: MPa)

Rated pressure range	-0.1 to 0	-0.1 to 0.1	-0.1 to 0.7	-0.1 to 1	-0.1 to 2
Expanded analog output range	-0.1 to 0.01	-0.1 to 0.12	-0.1 to 0.78	-0.1 to 1.11	-0.1 to 2.21
Max. pressure	0.6	0.6	3	3	3
Burst pressure	0.6	0.6	3	3	3
Compensation temperature	-10 to 80 °C				
Vibration	10 g, 20 to 2,000 Hz				
Shock	100 g / 6 ms				

■ Common



Output	Voltage (1 - 5 VDC≐) output	Current (DC 4 - 20 mA) output
Accuracy	≤ ± 0.5 %F.S. (including linearity, hysteresis, repeatability)	
Linearity	≤ ± 0.2 %F.S.	
Hysteresis	≤ ± 0.2 %F.S.	
Temp. zero shift	≤ ± 0.1 %F.S. / 10 °C (standard), ≤ ± 0.25 %F.S. / 10 °C (max.)	
Temp. span shift	≤ ± 0.1 %F.S. / 10 °C (standard), ≤ ± 0.25 %F.S. / 10 °C (max.)	
Load resistance	-	≤ 700 Ω (supplying 24 VDC≐)
Power supply	8 - 36 VDC≐ (ripple P-P: ≤ 10 %)	11 - 36 VDC≐ (ripple P-P: ≤ 10 %)
Allowable voltage range	90 to 110 % of rated voltage	
Current consumption	≤ 20 mA	≤ 30 mA
Connection	+, -, Vout	
Applicable medium	Gas, liquid, oil (except corrosive environment of SUS316)	
Pressure type	Gauge pressure, absolute pressure, sealed gauge pressure	
Rated pressure range	Different by model	
Response time	≤ 1 ms	
Insulation resistance	≥ 100 MΩ (500 VDC≐ megger)	
Dielectric strength	Between the charging part and the case: 500 VAC~ 50/60 Hz for 1 minute	
Tightening torque	≤ 10 Nm	
Ambient temperature ⁰¹⁾	-40 to 125 °C, storage: -40 to 125 °C (no freezing or condensation)	-40 to 85 °C, storage: -40 to 125 °C (no freezing or condensation)
Ambient humidity	35 to 85%RH, storage: 35 to 85%RH (no freezing or condensation)	
Medium temperature range	-40 to 125 °C	
Protection circuit	Reverse polarity protection circuit	
Material	SUS316L, SUS630 (Different by model), water-proof rubber: Silicon, head part of head type: Aluminium diecasting, connector: Polybutylene terephthalate G30	
Protection structure ⁰²⁾	IP67 (IEC standard)	
Certification	CE	
Unit weight (packaged)	Head type: ≈ 250 g (≈ 330 g) DIN43650-A / M12 / DT04-3P connector type: ≈ 50 g (≈ 130 g) cable type: ≈ 120 g (≈ 200 g)	

01) Cable type: -40 to 80 °C, storage: -40 to 80 °C (no freezing or condensation)

02) DIN43650-A connector type: IP65 (IEC standard)

Sold Separately: M12 Connector Cable

• For detailed information, refer to the 'M8/M12 Connector Cable' manual.

Appearance	Power	Connector 1	Connector 2	Length	Feature	Model
	DC	M12 (Socket-Female) 4-pin	3-wire	2 m	PVC	CID3-2
				5 m		CID3-5
	DC	M12 (Socket-Female) 4-pin, L type	3-wire	2 m	PVC	CLD3-2
				5 m		CLD3-5

Pressure Conversion Table

	Pa	kgf/cm ²	mmHg	mmH ₂ O	psi	bar	inHg
Pa	1	0.00010197	0.007501	0.101972	0.00014504	0.00001	0.0002953
kgf/cm²	98066.5	1	735.5592	10000.0005	14.223393	0.980665	28.959025
mmHg	133.3224	0.001359	1	13.595099	0.019337	0.001333	0.039370
mmH₂O	9.80665	0.000099	0.073556	1	0.00142	0.000098	0.002896
psi	6894.733	0.070307	51.71475	703.016716	1	0.068947	2.036014
bar	100000.0	1.019716	750.062	10197.1626	14.503824	1	29.529988
inHg	3386.388	0.034532	25.40022	345.315507	0.491156	0.033864	1

• 1,000,000 Pa = 1,000 kPa = 1 MPa

Troubleshooting

Fault	Troubleshooting
No outputs	Check the power supply. Check the polarity (+, -) when wiring the cable. Check the connection part.
Abnormally fluctuating output	Check the power supply. Check the supplied pressure. Check the pressure line.
Out of zero point output value	Check the power supply. Check the load resistive value of current output type for a receiver is over 700 Ω. (when supplying 24 VDC≐) Check the measuring point and transmission distance. Check the line resistance is below 700 Ω.