

Independent Single Display PID Temperature Controllers



TR1D Series PRODUCT MANUAL

For your safety, read and follow the considerations written in the instruction manual, other manuals and Autonics website.

The specifications, dimensions, etc are subject to change without notice for product improvement. Some models may be discontinued without notice.

Features

- Compact, space-saving design with 22.5 mm width size
- 50 ms high-speed sampling and $\pm 0.3\%$ display accuracy
- Simultaneous heating/cooling function
- Switch between current output and SSR drive output
- Easy mount on DIN rails
- RS485 communication output model available
 - Protocol: Modbus RTU or ASCII
 - Communication speed: up to 115,200 bps
- Parameter setting via PC (USB or RS485 communication)
 - Comprehensive device management software (DAQMaster) provided
- Heater disconnect alarm function (CT input)
 - Current transformer (CT) sold separately: CSTC-E80LN, CSTC-E200LN, CSTS-E80PP
- Screen protection function

Safety Considerations

- Observe all 'Safety Considerations' for safe and proper operation to avoid hazards.
- **⚠** symbol indicates caution due to special circumstances in which hazards may occur.

⚠ Warning Failure to follow instructions may result in serious injury or death

- 01. Fail-safe device must be installed when using the unit with machinery that may cause serious injury or substantial economic loss.** (e.g. nuclear power control, medical equipment, ships, vehicles, railways, aircraft, combustion apparatus, safety equipment, crime/disaster prevention devices, etc.)
Failure to follow this instruction may result in personal injury, economic loss or fire.
- 02. Do not use the unit in the place where flammable/explosive/corrosive gas, high humidity, direct sunlight, radiant heat, vibration, impact or salinity may be present.**
Failure to follow this instruction may result in explosion or fire.
- 03. Install the unit on DIN rail to use.**
Failure to follow this instruction may result in electric shock.
- 04. Do not connect, repair, or inspect the unit while connected to a power source.**
Failure to follow this instruction may result in fire or electric shock.
- 05. Check 'Connections' before wiring.**
Failure to follow this instruction may result in fire.
- 06. Do not disassemble or modify the unit.**
Failure to follow this instruction may result in fire or electric shock.

⚠ Caution Failure to follow instructions may result in injury or product damage

- 01. When connecting the power input and relay output, use AWG 20 (0.50 mm²) cable or over, and tighten the terminal screw with a tightening torque of 0.74 to 0.90 N m.**
When connecting the sensor input and communication cable without dedicated cable, use AWG 28 to 16 cable and tighten the terminal screw with a tightening torque of 0.74 to 0.90 N m.
Failure to follow this instruction may result in fire or malfunction due to contact failure.
- 02. Use the unit within the rated specifications.**
Failure to follow this instruction may result in fire or product damage
- 03. Use a dry cloth to clean the unit, and do not use water or organic solvent.**
Failure to follow this instruction may result in fire or electric shock.
- 04. Keep the product away from metal chip, dust, and wire residue which flow into the unit.**
Failure to follow this instruction may result in fire or product damage.

Cautions during Use

- Follow instructions in 'Cautions during Use'. Otherwise, it may cause unexpected accidents.
- Check the polarity of the terminals before wiring the temperature sensor.
For RTD temperature sensor, wire it as 3-wire type, using cables in same thickness and length. For thermocouple (CT) temperature sensor, use the designated compensation wire for extending wire.
- Keep away from high voltage lines or power lines to prevent inductive noise.
In case of installing power line and input signal line closely, use line filter or varistor at power line and shielded wire at input signal line.
Do not use near the equipment which generates strong magnetic force or high frequency noise.
- Do not apply excessive power when connecting or disconnecting the connectors of the product.
- Install a power switch or circuit breaker in the easily accessible place for supplying or disconnecting the power.
- Do not use the unit for other purpose (e.g. voltmeter, ammeter), but temperature controller.

- When changing the input sensor, turn off the power first before changing. After changing the input sensor, modify the value of the corresponding parameter.
- Do not overlapping communication line and power line. Use twisted pair wire for communication line and connect ferrite bead at each end of line to reduce the effect of external noise.
- Make a required space around the unit for radiation of heat. For accurate temperature measurement, warm up the unit over 20 min after turning on the power.
- Make sure that power supply voltage reaches to the rated voltage within 2 sec after supplying power.
- Do not wire to terminals which are not used.
- This unit may be used in the following environments.
 - Indoors (in the environment condition rated in 'Specifications')
 - Altitude Max. 2,000 m
 - Pollution degree 2
 - Installation category II

Ordering Information

This is only for reference, the actual product does not support all combinations. For selecting the specified model, follow the Autonics website.

T	R	1	D	-	①	②	③	④
---	---	---	---	---	---	---	---	---

① Option output

1: Alarm output 1
R: Alarm output 1, Transmission output 1
T: Alarm output 1, RS485 communication

② Control output1

R: Relay
C: Current/SSR

② Power supply

4: 100-240 VAC 50/60Hz

④ Control output2

PN	Control output2	Additional function
N	None	-
R	Relay ↔ Alarm output 2	CT input
C	Current/SSR ↔ Transmission output 2	CT input

Product Components

- Product (+ bracket)
- Instruction manual

Manual

For proper use of the product, refer to the manuals and be sure to follow the safety considerations in the manuals. Download the manuals from the Autonics website.

Software

Download the installation file and the manuals from the Autonics website.

■ DAQMaster

DAQMaster is comprehensive device management program. It is available for parameter setting, monitoring.

Unit Descriptions

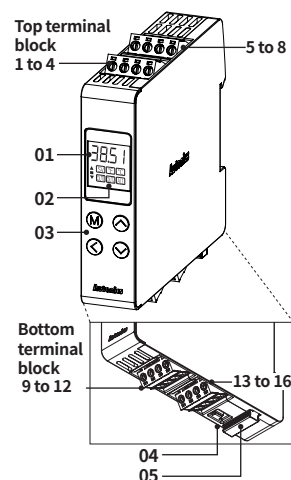

01. PV / SV display part (Red)

RUN mode: Displays PV (Present value) and SV (Setting value).
Parameter: Displays name and setting value of parameters.

02. Indicator

Indicator	ON condition
SV	SV display
OUT □	Control output □ ON
AL1	AL1 alarm output ON
▲	Displays PV deviation based on SV (Setting value) by LED. ▲: when deviation is over +2 °C ■: when deviation is within ±2 °C ▼: when deviation is under -2 °C Flashes during auto tuning every 1 sec
■	
▼	
°C / °F	'2-2 Temperature unit' parameter setting

03. Control key

[M]: MODE key
[◀] / [▲] / [▼]: Setting value control key

04. PC loader port

Communication converter (SCM-USP, Sold separately) connection

05. Bracket handle

Use to mount and detach the DIN rail.

Specifications

Series		TR1D Series
Power supply		100 - 240 VAC ~ 50/60 Hz
Permissible voltage range		90 to 110% of rated voltage
Power consumption		≤ 8 VA
Sampling period		50, 100, 250 ms
Input specification		Refer to 'Input Type and Using Range'.
Option input	CT input	<ul style="list-style-type: none"> • 0.0-50.0 A (primary current measurement range) • CT ratio: 1/1,000, • Measurement accuracy: ±5% F.S. ±1digit
Control output	Relay	250 VAC ~ 3 A 1a
	SSR	12 VDC ≐ ±3 V, ≤ 20 mA
	Current	DC 4-20 mA or DC 0-20 mA (parameter), Load: ≤ 500 Ω
Option output	Alarm	AL1, AL2: 250 VAC ~ 3 A 1a
	Transmission	DC4-20 mA (Load resistance: ≤ 500 Ω, Output accuracy: ±0.3% F.S.)
	RS485 comm.	Modbus RTU / ASCII

Display type	7 segment (red), 4-digit	
Control type	ON/OFF, P, PI, PD, PID Control	
Hysteresis	Control output: 1 to 100 °C/°F (0.1 to 100.0 °C/°F) Alarm output: 1 to 100 °C/°F (0.1 to 50.0 °C/°F)	
Proportional band (P)	0.1 to 999.9 °C	
Integral time (I)	0 to 9,999 sec	
Derivative time (D)	0 to 9,999 sec	
Control cycle (T)	Relay output: 0.5 to 120.0 sec, SSR drive output: 0.5 to 120.0 sec	
Manual reset	0.0 to 100.0%	
Dielectric strength	Between the charging part and the case : 3,000 VAC ~ 50/60 Hz for 1 min	
Vibration	0.75 mm amplitude at frequency of 5 to 55Hz in each X, Y, Z direction for 2 hours	
Relay life cycle	Mechanical	OUT1/2, AL1/2: ≥ 5,000,000 operations
	Electrical	OUT1/2, AL1/2: ≥ 100,000 operations (resistance load: 250 VAC ~ 5 A)
Insulation resistance	≥ 100 MΩ (500 VDC ≐ megger)	
Insulation type	Double insulation or reinforced insulation (dielectric strength between the charging part and the case: 3 kV)	
Noise immunity	Square shaped noise (pulse width: 1 μs) by noise simulator ±2 kV R-phase, S-phase	
Memory retention	≈ 10 years (non-volatile semiconductor memory type)	
Ambient temperature	-10 to 50 °C, storage: -20 to 60 °C (no freezing or condensation)	
Ambient humidity	35 to 85%RH, storage: 35 to 85%RH (no freezing or condensation)	
Certification	CE, ENEC	
Unit weight (packaged)	≈ 123.5 g (≈ 194.5 g)	

Communication Interface

■ RS485

Communication protocol	Modbus RTU / ASCII
Application standard	EIA RS485 compliance with
Maximum connection	31 units (address: 01 to 127)
Synchronous method	Asynchronous
Communication method	Two-wire half duplex
Communication effective range	≤ 800 m
Communication speed	4,800 - 9,600 (default) - 19,200 - 38,400 - 57,600 - 115,200 bps (parameter)
Response time	5 to 99 ms (default: 20 ms)
Start bit	1 bit (fixed)
Data bit	8 bit (fixed)
Parity bit	None (default), Odd, Even
Stop bit	1 bit, 2 bit (default)
EEPROM life cycle	≈ 1,000,000 operations (Erase / Write)

- It is recommended to use Autonics communication converter. Please use twisted pair wire, which is suitable for RS485 communication.

Input Type and Using Range

- The setting range of some parameters is limited when using the decimal point display.

Input type	Decimal point	Display Method	Using range(°C)	Using range(°F)	
Thermo-couple	K (CA)	1 0.1	ℓℓRH ℓℓRL	-50 to 1,200 -58.0 to 999.9	-58 to 2,192 -58.0 to 999.9
	J (IC)	1 0.1	JℓCH JℓCL	-30 to 800 -30.0 to 800.0	-22 to 1,472 -22.0 to 999.9
	L (IC)	1 0.1	LℓCH LℓCL	-40 to 800 -40.0 to 800.0	-40 to 1,472 -40.0 to 999.9
	T (CC)	1 0.1	ℓℓCH ℓℓCL	-50 to 400 -50.0 to 400.0	-58 to 752 -58.0 to 752.0
	R (PR)	1	rPR	0 to 1,700	32 to 3,092
	S (PR)	1	sPR	0 to 1,700	32 to 3,092
RTD	DPT100Ω	1 0.1	dPℓH dPℓL	-100 to 400 -100.0 to 400.0	-148 to 752 -148.0 to 752.0
	Cu50Ω	1 0.1	ℓℓSH ℓℓSL	-50 to 200 -50.0 to 200.0	-58 to 392 -58.0 to 392.0
	Nickel120Ω	1	nℓℓ	-80 to 260	-112 to 500

Display accuracy

- The setting range of some parameters is limited when using the decimal point display.

Input type	Using temperature	Measurement accuracy
Thermocouple RTD	At room temperature (23°C±5°C)	(PV ±0.3% or ±1°C higher one) ±1-digit • Thermocouple R (PR), S (PR) below 200°C: (PV ±0.5% or ±3°C higher one) ±1-digit, Over 200°C: (PV ±0.5% or ±2°C higher one) ±1-digit, • Thermocouple L (IC), RTD Cu50Ω: (PV ±0.5% or ±2°C higher one) ±1-digit
	Out of room temperature range	(PV ±0.5% or ±2°C higher one) ±1-digit • Thermocouple R (PR), S (PR): (±1.0% or ±5°C higher one) ±1-digit • Thermocouple L (IC), RTD Cu50Ω: (PV ±0.5% or ±3°C higher one) ±1-digit

- When multiple products (or more) are mounted without separation, ±1°C is added to all accuracy.

Dimensions

- Unit: mm, For the detailed drawings, follow the Autonics website.

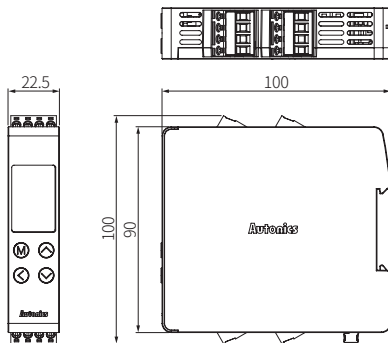

Connections

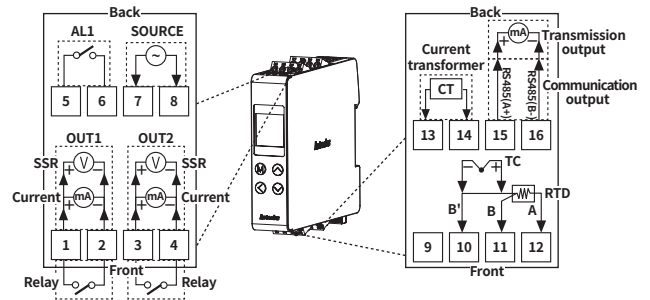

Terminal support by model

Terminal No.	1	2	3	4	5	6	7	8	9	10	11	12	13	14	15	16
Function	Control output 1	Control output 2	Alarm output	Power	-	Temperature sensor input	CT input	Option output								
Model																
TR1D-14RN	Relay	-	Relay	○	-	TC RTD	-	-	-	-	-	-	-	-	-	-
TR1D-14RR	Relay	Relay	Relay	○	-	TC RTD	-	○	-	-	-	-	-	-	-	-
TR1D-R4RR	Relay	Relay	Relay	○	-	TC RTD	-	○	-	-	-	-	-	Trans- mission	-	-
TR1D-T4RR	Relay	Relay	Relay	○	-	TC RTD	-	○	-	-	-	-	-	Communi- cation	-	-
TR1D-14CN	Current SSR	-	Relay	○	-	TC RTD	-	-	-	-	-	-	-	-	-	-
TR1D-14CC	Current SSR	Current SSR	Relay	○	-	TC RTD	-	○	-	-	-	-	-	-	-	-
TR1D-R4CC	Current SSR	Current SSR	Relay	○	-	TC RTD	-	○	-	-	-	-	-	Trans- mission	-	-
TR1D-T4CC	Current SSR	Current SSR	Relay	○	-	TC RTD	-	○	-	-	-	-	-	Communi- cation	-	-

Initial Display When Power is ON

When power is supplied, after all display will flash for a while, series and model name are displayed sequentially. After input sensor type will flash twice, enter into RUN mode.

All display	Series	Model	Input specification	Run mode
8888. ▲ SV °F °C ▼ OUT1 OUT2 ALI	ℓrℓd °C	ℓ4rr °C	ℓCAH °C	26.6 °C OUT1 OUT2 ALI

Errors

Display	Description	Troubleshooting
αPEα	Flashes if input sensor is disconnected or sensor is not connected.	Check input sensor status.
HHHH	Flashes when PV is higher than input range. ⁰¹⁾	When input is within the rated temperature range, this display disappears.
LLLL	Flashes when PV is lower than input range. ⁰¹⁾	

01) Be careful that when HHHH / LLLL error occurs, the control output may occur by recognizing the maximum or minimum input depending on the control type.

Installation Method

Mounting on DIN rail

- Mount the metal part with a spanner so that a large force is not applied to the body.

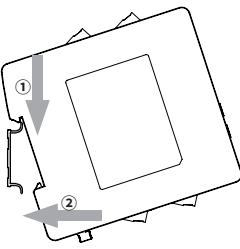
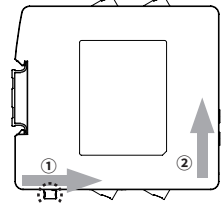
Install	Uninstall
	
<ol style="list-style-type: none"> Hang the top of backside holder to 35 mm width DIN rail. Press the unit in the direction of the arrow until there is clicking sound. 	<ol style="list-style-type: none"> Pull the bracket handle on the bottom of the unit in the direction of the arrow. Lift the unit up while pulling the handle bracket to remove.

Attaching and Detaching a Terminal Unit

Detaching

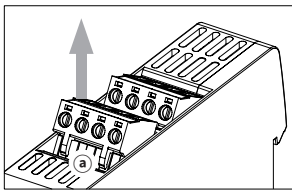

Lift the lower part of the terminal unit ② upwards by using a tool (e.g. flat-head driver).

- When disconnecting terminal unit and wiring, refer to 'Connections' to attach to right position. Failure to follow this instruction may result in fire product damage or malfunction.

Attaching

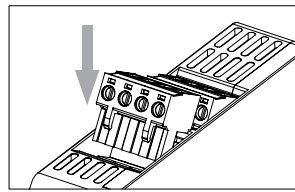

Press the terminal unit downwards to insert.

Mode Setting

RUN	[▲] key over 2 sec →	Display part switching	Auto	→	RUN
	No key input over screen protection time →	Screen protection	[M], [◀], [▲], [▼] key	→	
	[▼] + [▲] key over 3 sec →	Digital input key	Auto	→	
	[M], [◀], [▲] or [▼] key →	SV setting	[M] key or no key input over 3 sec	→	
	[M] key over 2 sec →	Parameter group	[M] key over 2 sec	→	
	[◀] + [▲] + [▼] key over 3 sec →	Parameter reset	Refer to 'Parameter Reset'	→	

Parameter Reset

- Press the [◀] + [▲] + [▼] keys for over 5 sec. in run mode, INIT turns ON.
- Change the setting value as YES by pressing the [▲], [▼] keys.
- Press the [M] key to reset all parameter values as default and to return to run mode.

Parameter Setting

- Some parameters are activated/deactivated depending on the model or setting of other parameters. Refer to the descriptions of each item.
- Select group by [▲], [▼] key and press [M] key to parameter setting mode in parameter group setting mode.
- [M] key: Move to next item after saving / Return to upper level with save (≥ 2 sec)
- [◀] key: Move digits / Return to the upper level without saving (≥ 2 sec) / Return to RUN mode without saving (≥ 3 sec)
- [▲], [▼] key: Select parameter / Change setting value
- Return to the upper level without saving when there is no key input for more than 30 seconds.
- The range in parentheses '(')' is the setting range when the set value of the 'input specification' parameter is used with one decimal point.
- Recommended parameter setting sequence: Parameter 2 group → Parameter 1 group → SV setting mode

Parameter 1 group

Parameter	Display	Default	Setting range	Condition
1-1 Lock	L o C k	o F F	OFF LOC1: Lock parameter 2 group LOC2: Lock parameter 1, 2 group LOC3: Lock parameter 1, 2 group + SV setting lock • It is possible to check the value only in lock mode.	-
1-2 Heater current monitoring	C t - A	-	[CT input model] 0.0 to 50.0 A	2-10/11 Control output 1/2: SSR
1-3 Auto tuning	A t	o F F	OFF, ON: Execution	2-9 Control type: PID
1-4 AL1 alarm temperature	A L 1	1 2 5 0	Deviation alarm: -F.S. to F.S. °C/°F Absolute value alarm: Within input specification • Changing the '2-16/19 AL1/2 alarm operation' and '2-17/20 AL1/2 alarm option' will automatically reset the value to the maximum or minimum that will not be output.	2-16/19 AL1/2 alarm operation: AM1 to AM6, HBA
1-5 AL2 alarm temperature	A L 2	1 2 5 0		
1-6 Heating proportional band	H - P	1 0	0.1 to 999.9 °C/°F	-
1-7 Heating integral time	H - I	2 4 0	0 (OFF) to 9999 sec	-
1-8 Heating derivative time	H - d	4 9	0 (OFF) to 9999 sec	-
1-9 Cooling proportional band	C - P	1 0	0.1 to 9999 °C/°F	-
1-10 Cooling integral time	C - I	2 4 0	0 (OFF) to 9999 sec	-
1-11 Cooling derivative time	C - d	4 9	0 (OFF) to 9999 sec	-
1-12 Dead band ⁽⁰¹⁾	d b	0	-Proportional band to +Proportional band °C/°F -999 to 999 (-199.9 to 999.9) °C/°F	2-9 Control type: P,P, P,ON, ON,P 2-9 Control type: ON,ON
1-13 Manual reset	r E S E t	5 0	0.0 to 100.0%	1-7/10 Heating/Cooling integral time: 0
1-14 Heating hysteresis	H H Y S	2	1 to 100 (0.1 to 100.0) °C/°F	2-9 Control type: ONOF &
1-15 Heating OFF offset	H o S E t	0	0 to 100 (0.0 to 100.0) °C/°F	2-8 Control output mode ⁽⁰²⁾
1-16 Cooling hysteresis	C, H Y S	2	1 to 100 (0.1 to 100.0) °C/°F	
1-17 Cooling OFF offset	C, o S E t	0	0 to 100 (0.0 to 100.0) °C/°F	

01) When set to the + value, the dead band is formed based on SV and does not control any control. When set to the - value, the overlap band is formed based on SV, perform the heating and cooling control at the same time.

02) Parameter display following to the setting value of '2-8 Control output mode'
HEAT: '1-14 & 15 Heating hysteresis & OFF offset'
COOL: '1-16 & 17 Cooling hysteresis & OFF offset'
H-C: '1-14 & 15 Heating hysteresis & OFF offset', '1-16 & 17 Cooling hysteresis & OFF offset'

Parameter 2 group

Parameter	Display	Default	Setting range	Condition
2-1 Input specification	I n - t	P C R H	Refer to 'Input Type and Using Range'	-
2-2 Temperature unit	U n i t	° C	°C, °F	-
2-3 Sampling period	S P L t	5 0	50, 100, 250 ms	-
2-4 Input correction	i n - b	0	-999 to 999 (-199.9 to 999.9) °C/°F	-
2-5 Input digital filter	A R w F	0. 1	0.1 to 120.0 sec	-
2-6 SV low limit value	L - S v	- 5 0	Within 2-1 Input specification L-SV \leq H-SV - 1-digit °C/°F	-
2-7 SV high limit value	H - S v	1 2 0 0	H-SV \geq L-SV + 1-digit °C/°F	-
2-8 Control output mode	o - F E t	H - C	HEAT: Heating ⁽⁰¹⁾ , COOL: Cooling ⁽⁰¹⁾ , H-C: Heating (OUT1) & Cooling (OUT2) ⁽⁰²⁾	-
2-9 Control type	C - t y p e	P, P	PID, ONOF: ON/OFF, P,P: PID-PID*, ON,ON: ON/OFF-ON/OFF*, P,ON: PID-ON/OFF*, ON,P: ON/OFF-PID*	* 2-8 Control output mode: H-C

Parameter	Display	Default	Setting range	Condition
2-10 Control output 1	oUti	CUrr	[Current/SSR output model] SSR, CURR: Current	-
2-11 Control output 1 range	oLhR	4-20	4-20, 0-20 mA	2-10/12 Control output 1/2: CURR
2-12 Control output 2	oUte	CUrr	[Current/SSR output model] SSR, CURR: Current	-
2-13 Control output 2 range	oLhR	4-20	4-20, 0-20 mA	2-10/12 Control output 1/2: CURR
2-14 Heating control cycle	H-t	200	[Relay output model] 0.5 to 120.0 sec	-
		20	[Current/SSR output model] 0.5 to 120.0 sec	2-10/12 Control output 1/2: SSR
2-15 Cooling control cycle	C-t	200	[Relay output model] 0.5 to 120.0 sec	-
		20	[Current/SSR output model] 0.5 to 120.0 sec	2-10/12 Control output 1/2: SSR
2-16 AL1 alarm operation	AL-1	AM0: OFF AM1: Deviation high limit alarm AM2: Deviation low limit alarm AM3: Deviation high, low limit alarm AM4: Deviation high, low limit reserve alarm AM5: Absolute value high limit alarm AM6: Absolute value low limit alarm SBA: Sensor break alarm LBA: Loop break alarm ⁽⁴⁾ HBA: Heater break alarm		-
		<ul style="list-style-type: none"> ■ A: Standard alarm, B: Alarm latch, C: Standby sequence 1, D: Alarm latch and sequence 1, E: Standby sequence 2, F: Alarm latch and sequence 2 • Enter to option setting: Press [◀] key in 2-16 AL-1 alarm operation. 		
2-17 AL1 alarm option				-
2-18 AL1 Hysteresis	RlHY	1	1 to 100 (0.1 to 50.0) °C/°F	2-16/17 AL1/2 Alarm operation: AM1 to AM6 or HBA
2-19 AL2 alarm operation	AL-2	RhZR	[Alarm output 2 model] Same as '2-16/17 AL1 alarm operation/option'	2-8 Control output mode: HEAT or COOL
2-20 AL2 alarm option				
2-21 AL2 hysteresis	RZHY	1	[Alarm output 2 model] 1 to 100 (0.1 to 50.0) °C/°F	2-16/17 AL1/2 Alarm operation: AM1 to AM6 or HBA
2-22 LBA time ⁽⁴⁾	tbrt	0	0 to 9999 sec or auto setting ⁽⁵⁾	2-16/17
2-23 LBA band	tbrb	2	0 to 999 (0.0 to 999.9) °C/°F or Auto setting ⁽⁶⁾	AL1/2 alarm operation: LBA
2-24 Transmission output1 mode	Ran1	Pu	[Transmission output model] PV, SV, H-MV: Heating MV, C-MV: Cooling MV	
2-25 Transmission output1 low limit	F5L	-50	[Transmission output model] Refer to 'Input Type and Using Range'	
2-26 Transmission output1 high limit	F5H	1200		
2-27 Transmission output2 mode	Ran2	Pu	[Transmission output 2 model] PV, SV, H-MV: Heating MV, C-MV: Cooling MV	2-8 Control output mode: HEAT or COOL
2-28 Transmission output2 low limit	F5L	-50	[Transmission output 2 model] Refer to 'Input Type and Using Range'	
2-29 Transmission output2 high limit	F5H	1200		
2-30 Digital input key	d1-y	5tOP	STOP: Stop control output, ALRE: Alarm reset, AT: Auto tuning execution, OFF	-
2-31 Sensor error, MV	Ernu	0	0.0 (OFF) to 100.0 (ON)	2-8 Control output mode: HEAT or COOL
		0	-100 (Cooling ON) to 0.0 (OFF) to 100 (Heating ON)	2-8 Control output mode: H-C
2-32 Screen protection	d5P	OFF	OFF, 1, 30, 60 min	-
2-33 Comm. protocol	PrL	rLU	RTU: Modbus RTU, ASCII: Modbus ASCII	-
2-34 Comm. address	Rdr5	1	1 to 99	-
2-35 Comm. speed	bP5	96	48, 96, 192, 384, 576, 1152 (×100) bps	-
2-36 Comm. parity bit	Prty	nanE	None, Even, Odd	-
2-37 Comm. stop bit	StP	2	1, 2 bit	-
2-38 Response time	r5t	20	5 to 99 ms	-
2-39 Comm. write	CnW	ENR	EN.A: Enable, DIS.A: Disable	-
2-40 Parameter reset	iniE	no	YES, NO	-

- 01) [Alarm output2 model] 'Control output 2 terminal' operates as 'alarm output 2'.
[Transmission output2 model] 'Control output 2 terminal' operates as 'transmission output 2'.
- 02) [Control output 2 terminal not support model] 'Alarm output 1 terminal' operates as 'control output 2'.
03) Operates based on 'Control output 1'
- 04) - Initialization condition of LBA time (alarm output status)
Alarm reset, change '2-8 Control output mode' (standard alarm: OFF, alarm latch: OFF),
Change '2-4 Input correction' or SV (Standard alarm: latch, alarm latch: latch),
Error status: OPEN, HHHH, LLLL (Standard alarm: Immediately ON, alarm latch: Immediately ON)
- Stop condition of LBA operation (Alarm output status)
Set '2-22/23 LBA time/band: 0' (standard alarm: OFF, alarm latch: latch)
Stop control output, execute auto tuning (standard alarm: OFF, alarm latch: latch),
If '2-1 Input specification' is changed, the settings are initialized.
- 05) After auto tuning, the range is set as twice of the integral time automatically. If the previous setting value is outside of the range automatically set, it is set to the nearest Max. or Min. value of the range.
- 06) After auto tuning, the range is set as 10% of the proportion band automatically. If the previous setting value is outside of the range automatically set, it is set to the nearest Max. or Min. value of the range.

Function: Alarm

000.0

Alarm operation Alarm option

Set both alarm operation and alarm option by combining. Each alarm operates individually in two alarm output models. When the current temperature is out of alarm range, alarm clears automatically.

Operation

• H: Alarm output hysteresis

Name	Alarm operation	Description
-	-	No alarm output
Deviation high limit		If deviation between PV and SV as high-limit is higher than set value of deviation temperature, the alarm output will be ON.
	<p>High deviation: Set as 10°C</p> <p>High deviation: Set as -10°C</p>	
Deviation low limit		If deviation between PV and SV as low limit is higher than set value of deviation temperature, the alarm output will be ON.
	<p>Low deviation: Set as 10°C</p> <p>Low deviation: Set as -10°C</p>	
Deviation high, low limit		If deviation between PV and SV as high/low-limit is higher than set value of deviation temperature, the alarm output will be ON.
	<p>High, Low deviation: Set as 10°C</p>	
Deviation high, low limit reverse		If deviation between PV and SV as high/low-limit is lower than set value of deviation temperature, the alarm output will be OFF.
	<p>High, Low deviation: Set as 10°C</p>	
Absolute value high limit		If PV is higher than the absolute value, the output will be ON.
	<p>Absolute value: Set as 90°C</p> <p>Absolute value: Set as 110°C</p>	
Absolute value low limit		If PV is lower than the absolute value, the output will be ON.
	<p>Absolute value: Set as 90°C</p> <p>Absolute value: Set as 110°C</p>	
Sensor break	-	It will be ON when it detects sensor disconnection.
Heater break	-	It will be ON when it detects heater disconnection.
Loop break	-	It will be ON when it detects loop disconnection.

Option

Name	Description	Condition of re-apply
Standard alarm	If it is an alarm condition, alarm output is ON. If it is a clear alarm condition, alarm output is OFF.	-
Alarm latch	If it is an alarm condition, alarm output is ON and maintains ON status.	-
Standby sequence 1	First alarm condition is ignored and from second alarm condition, standard alarm operates. When power is supplied and it is an alarm condition, this first alarm condition is ignored and from the second alarm condition, standard alarm operates.	Power ON
Alarm latch and standby sequence 1	If it is an alarm condition, it operates both alarm latch and standby sequence. When power is supplied and it is an alarm condition, this first alarm condition is ignored and from the second alarm condition, alarm latch operates.	Power ON
Standby sequence 2	First alarm condition is ignored and from second alarm condition, standard alarm operates. When re-applied standby sequence and if it is alarm condition, alarm output does not turn ON. After clearing alarm condition, standard alarm operates.	Power ON, change SV, change alarm temperature / operation or change STOP to RUN mode
Alarm latch and standby sequence 2	Basic operation is same as alarm latch and standby sequence 1. It operates not only by power ON/OFF, but also alarm set value, or alarm option changing. When re-applied standby sequence and if it is alarm condition, alarm output does not turn ON. After clearing alarm condition, alarm latch operates.	Power ON, change SV, change alarm temperature / operation or change STOP to RUN mode

Segment Table

7 Segment				11 Segment				12 Segment				16 Segment			
0	0	1	1	0	0	1	1	0	0	1	1	0	0	1	1
1	1	2	2	1	1	2	2	1	1	2	2	1	1	2	2
2	2	3	3	2	2	3	3	2	2	3	3	2	2	3	3
3	3	4	4	3	3	4	4	3	3	4	4	3	3	4	4
4	4	5	5	4	4	5	5	4	4	5	5	4	4	5	5
5	5	6	6	5	5	6	6	5	5	6	6	5	5	6	6
6	6	7	7	6	6	7	7	6	6	7	7	6	6	7	7
7	7	8	8	7	7	8	8	7	7	8	8	7	7	8	8
8	8	9	9	8	8	9	9	8	8	9	9	8	8	9	9
9	9	10	10	9	9	10	10	9	9	10	10	9	9	10	10
A	A	11	11	A	A	11	11	A	A	11	11	A	A	11	11
b	b	12	12	b	b	12	12	b	b	12	12	b	b	12	12
c	c	13	13	c	c	13	13	c	c	13	13	c	c	13	13
d	d	14	14	d	d	14	14	d	d	14	14	d	d	14	14
e	e	15	15	e	e	15	15	e	e	15	15	e	e	15	15
f	f	16	16	f	f	16	16	f	f	16	16	f	f	16	16
g	g	17	17	g	g	17	17	g	g	17	17	g	g	17	17
h	h	18	18	h	h	18	18	h	h	18	18	h	h	18	18