

100 mm Hybrid Recorder



KRN100 Series PRODUCT MANUAL

For your safety, read and follow the considerations written in the instruction manual, other manuals and Autonics website.

The specifications, dimensions, etc. are subject to change without notice for product improvement. Some models may be discontinued without notice.

Features

- 100 mm paper recorder
- Writable data logger function without paper (supports internal memory and external USB memory data backup)
- 25 to 250ms high speed sampling, 10 to 240mm/H high graph mode recording
- 6 kinds of recording color
- Easy parameter setting by quick menu
- Internal parameter setting and monitoring via USB, RS485, Ethernet communication
- High visibility and convenient setting with graphic LCD
- Various inputs of up to 12 channels with slot type input card
- Total 27 types of input specifications (weight, voltage, current, frequency, potentiometer, and various input card can be ordered)
- Reduced installation space with small size (rear length: 168mm)

Safety Considerations

- Observe all 'Safety Considerations' for safe and proper operation to avoid hazards.
- ⚠ symbol indicates caution due to special circumstances in which hazards may occur.

⚠ Warning Failure to follow instructions may result in serious injury or death.

- 01. Fail-safe device must be installed when using the unit with machinery that may cause serious injury or substantial economic loss. (e.g. nuclear power control, medical equipment, ships, vehicles, railways, aircraft, combustion apparatus, safety equipment, crime / disaster prevention devices, etc.)**
Failure to follow this instruction may result in personal injury, economic loss or fire.
- 02. Do not connect, repair, or inspect the unit while connected to a power source.**
Failure to follow this instruction may result in fire or electric shock.
- 03. Check 'Connections' before wiring.**
Failure to follow this instruction may result in fire.
- 04. Do not touch the unit during or after operation for a while.**
Failure to follow this instruction may result in burn or electric shock due to high temperature of the surface.
- 05. Do not use the unit in the place where flammable / explosive / corrosive gas, high humidity, direct sunlight, radiant heat, vibration, impact or salinity may be present.**
Failure to follow this instruction may result in explosion or fire.
- 06. Install on the device panel, and ground to the F.G. terminal separately. When connecting the F.G. terminal, use AWG16 (1.25 mm²) or over.**
Failure to follow this instruction may result in fire or electric shock.
- 07. Do not disassemble or modify the unit.**
Failure to follow this instruction may result in fire.
- 08. Since Lithium battery is embedded in the product, do not disassemble or burn the unit.**
Failure to follow this instruction may result in fire.

⚠ Caution Failure to follow instructions may result in injury or product damage.

- 01. Use the unit within the rated specifications.**
Failure to follow this instruction may result in fire or product damage.
- 02. Use a dry cloth to clean the unit, and do not use water or organic solvent.**
Failure to follow this instruction may result in fire or electric shock.
- 03. Keep the product away from metal chip, dust, and wire residue which flow into the unit.**
Failure to follow this instruction may result in fire or product damage.
- 04. When connecting the power input or measurement input, use AWG20 (0.50 mm²) cable or over, and tighten the terminal screw with a tightening torque of 0.74 N·m to 0.90 N·m.**
Failure to follow this instruction may result in fire or malfunction due to contact failure.
- 05. Do not use the load beyond rated switching capacity contact.**
Failure to follow this instruction may result in fire, relay broken, contact melt, insulation failure or contact failure.
- 06. Use the transmitter output card only for the power for the transmitter.**
Failure to follow this instruction may result in output module damage.
- 07. When connecting the temperature sensor (TC, RTD) or analogue input (voltage, current) as input to the universal input card, set the jumper pin to the correct place for the connected input type.**
If the jumper pin is placed improperly, it may result in product damage or malfunction.

Cautions during Use

- Follow instructions in 'Cautions during Use'. Otherwise, it may cause unexpected accidents.
- Install a surge absorber at each end of inductive load coil when controlling high-capacity power relay or inductive load (e.g. magnet).
- Check the polarity of the terminals before wiring the temperature sensor. For RTD temperature sensor, wire it as 3-wire type, using cables in same thickness and length. For thermocouple (CT) temperature sensor, use the designated compensation wire for extending wire.
- Keep away from high voltage lines or power lines to prevent inductive noise. In case installing power line and input signal line closely, use line filter or varistor at power line and shielded wire at input signal line. Do not use near the equipment which generates strong magnetic force or high frequency noise.
- Keep the ink cartridge in its original packaging, away from excessive sunlight, and protected from water or dust contamination. Otherwise, it may cause deterioration of the ink, such as leaking or hardening.
- This unit may be used in the following environments.
 - Indoors (in the environment condition rated in 'Specifications')
 - Altitude max. 2,000 m
 - Pollution degree 2
 - Installation category II

Ordering Information

This is only for reference, the actual product does not support all combinations. For selecting the specified model, follow the Autonics website.

KRN100 - ① ② ③ ④ - ⑤ ⑥ - ⑦ ⑧

① Input channel

02: 2 CH (universal input card × 1)
04: 4 CH (universal input card × 2)
06: 6 CH (universal input card × 3)
08: 8 CH (universal input card × 4)
10: 10 CH (universal input card × 5)
12: 12 CH (universal input card × 6)

② Digital input

0: None
1: 6 (digital input card × 1)
2: 12 (digital input card × 2)

③ Alarm transistor output

0: None
1: 6 (transistor alarm output card × 1)
2: 12 (transistor alarm output card × 2)

④ Alarm relay output

0: None
1: 4 (relay alarm output card × 1)
2: 8 (relay alarm output card × 2)
3: 12 (relay alarm output card × 3)

⑤ Transmitter power output

0: None
1: 3 (transmitter power output card × 1)
2: 6 (transmitter power output card × 2)
3: 9 (transmitter power output card × 3)
4: 12 (transmitter power output card × 4)

⑥ Communication output

0: None
1: RS485 / Ethernet / USB
(communication output card × 1)

⑦ Power supply

0: 100 - 240 VAC~

⑧ Case shape

S: Standard panel installation type

Manual

For proper use of the product, refer to the manuals and be sure to follow the safety considerations in the manuals.

Download the manuals from the Autonics website.

Software

Download the installation file and the manuals from the Autonics website.

■ DAQMaster

It is the comprehensive device management program for Autonics' products, providing parameter setting, monitoring and data management.

Product Components

- Product
- Recording paper
- Instruction manual
- USB memory
- Ink cartridge
- Bracket × 2
- Basic connector × 2 (the no. of additional connectors depends on the input/output card.)

Sold Separately

- Universal input card: KRN-UI2
- Transistor alarm output card: KRN-AT6
- Transmitter power output card: KRN-24V3
- Digital input card: KRN-DI6
- Relay alarm output card: KRN-AR4
- Communication output card: KRN-COM

Specifications

Series	KRN100
LCD type	STN Graphic LCD
Resolution	320 × 120 pixel
Brightness adjustment	4-level (OFF / Min / Standard / Max)
Backlight	White LED, 2-level (Temp / Always)
No of input channel	2 / 4 / 6 / 8 / 10 / 12 CH model (2 CH / universal input card)
Universal input	Please refer to 'Input / Output' for detailed information about universal input.
Sampling cycle⁽¹⁾	1 to 4 CH: 25 ms / 125 ms / 250 ms, 5 to 12 CH: 125 ms / 250 ms (thermocouple (TC) - R, U, S, T; ≥ 50 ms)
Graph mode recording speed	10, 20, 40, 60, 120, 240 mm / H
Recording accuracy	± 0.5 % F.S.
Saving cycle	1 to 3,600 sec (inner log file is saved at 1 sec interval)
Internal memory	512 MB
External memory⁽²⁾	USB memory max. 32 GB
Recording paper	113 mm × 9 mm
Ink cartridge	Normal printing is available after going and returning printing maximum 5 times within 7 days after opening the unit (Manufacturer: Graphic Controls / Recommended use: within 2 years / Storage temp.: 17.2 to 22.8 °C / Humid.: 50 to 70 %RH)
Ink dry time	≤ 15 minutes

- 01) Internal sampling cycle is average movement filter and alarm output operation unit time.
02) USB memory is included in the box. If you use USB memory you purchased separately, it could not be recognized.

Power supply	100 - 240 VAC ~ 50 / 60 Hz
Permissible voltage range	85 to 110 % of rated power supply
Power consumption	≤ 55 VA
Dielectric strength	Between the charging part and the case: 2,500 VAC ~ 50 / 60 Hz for 1 minute (except Ethernet and USB device)
Vibration (conveying and storing)	10 to 60 Hz 4.9 m/s ² X, Y, Z in each X, Y, Z direction for 1 hour
Vibration (operating)	10 to 60 Hz 1 m/s ² X, Y, Z in each X, Y, Z direction for 10 minutes
Insulation resistance	≥ 20 MΩ (500 VDC = megger)
Noise immunity	± 2 kV square wave noise (pulse width 1 μs) by noise simulator
Time accuracy	Within ± 2 min / year (available up to 2100 year)
Protection structure	IP50 (front part, IEC standard)
Ambient temperature	0 to 50 °C, storage: -20 to 60 °C (without the ink cartridge, no freezing or condensation)
Ambient humidity	35 to 85 %RH, storage: 35 to 85 %RH (no freezing or condensation)
Certification	CE, RoHS, REACH
Unit weight (packaged)	≈ 1.7 to 2.0 kg (≈ 2.4 to 2.7 kg)

Input / Output

Connect or disconnect the input / output card when the product is turned off.

■ Universal input card (KRN-UI2)

• Input specifications

RTD	JPt100Ω, DPt100Ω, DPt50Ω, Cu100Ω, Cu50Ω (supplied current 420 μA)
Thermocouple	B, C (W5), E, G, J, K, L, L (Russia), N, P, R, S, T, U
Analog	Voltage ± 60 mV, ± 200 mV, ± 2 V, 1-5 V, ± 5 V, -1 V-10 V
	Current 0.00-20.00 mA, 4.00-20.00 mA

If sensor input line is longer, it is recommended to use shield cable to reduce noise.

• Input impedance

RTD, thermocouple, voltage (mV)	≥ 2 MΩ
Voltage (V)	≥ 150 kΩ
Current	51 Ω

• Display accuracy

Input type	Temperature	Display accuracy
RTD	Room temperature range (25 °C ± 5 °C)	± 0.1 % F.S. ± 1 digit (warm-up time: ≥ 30 minutes) • Cu50Ω (-200 ≤ T ≤ 200): ± 1.0 °C • DPt50Ω (-200 ≤ T ≤ 500): ± 1.5 °C
	Out of room temperature range	± 0.2 % F.S. ± 1 digit (warm-up time: ≥ 30 minutes) • 500 to 850 °C of all RTDs: ± 0.5 % of PV value ± 1 digit • Cu50Ω (-200 ≤ T ≤ 200): ± 2.0 °C • DPt50Ω (-200 ≤ T ≤ 500): ± 3.0 °C
Thermocouple	Room temperature range (25 °C ± 5 °C)	± 0.1 % F.S. ± 1 digit (warm-up time: ≥ 30 minutes) • R, S, C, G (0 ≤ T ≤ 100): ± 4.0 °C • U, T (200 ≤ T ≤ -100): ± 3.0 °C • U, T (-100 ≤ T ≤ 400): ± 2.0 °C • Below 400 °C of B: there is no accuracy standards. • Below -100 °C of all thermocouples: ± 0.3 % F.S. ± 1 digit
	Out of room temperature range	± 0.2 % F.S. ± 1 digit (warm-up time: ≥ 30 minutes)
Analog	Room temperature range (25 °C ± 5 °C)	± 0.1 % F.S. ± 1 digit (warm-up time: ≥ 30 minutes)
	Out of room temperature range	± 0.2 % F.S. ± 1 digit (warm-up time: ≥ 30 minutes)

• Resolution: 16 bit

■ Digital input card (KRN-DI6)

Non-contact input	ON: residual voltage ≤ 1 VDC=, OFF: leakage current ≤ 0.1 mA
Contact input	ON: ≤ 1 kΩ, OFF: ≥ 100 kΩ, short-circuit: ≈ 4 mA

■ Alarm transistor output card (KRN-AT6)

NPN Open Collector, 12-24 VDC= / ≤ 30 mA

■ Alarm relay output card (KRN-AR4)

Capacity	250 VAC ~ 3 A, 30 VDC = 3 A, 1 Form A (resistive load)
Mechanical life cycle	≥ 50,000,000 operations
Electrical life cycle	≥ 100,000 operations (250 VAC ~ 3 A, 30 VDC = 3 A)

■ Transmitter power output card (KRN-24V3)

24 ± 2 VDC=, total 3 CH, per 1 CH ≤ 30 mA (built-in over current protection circuit)

■ Communication output card (KRN-COM)

RS485	Modbus RTU (It is recommended to use shielded cable over AWG 24.)
EEPROM life cycle	≈ 1,000,000 operations (Erase / Write)
Ethernet	IEEE802.3(U), 10 / 100 BASE-T (Modbus TCP)
USB Device	USB V2.0 Full Speed (Device Control)

RS422 / 485 and Ethernet communication outputs cannot be used at the same time. The front USB Device port is only for data backup and rear USB device port is the same for parameter setting.

Input / Output Card

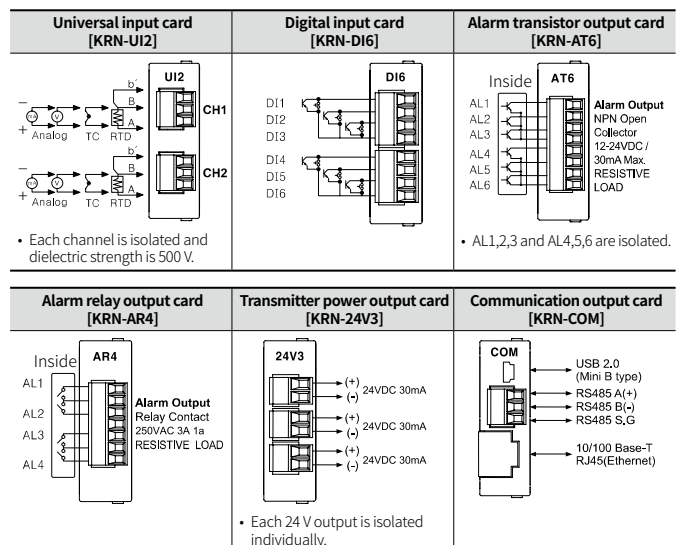

Input Type Setting

In the universal input card, place of jumper pin is different by input type.
Before setting the parameters, set the jumper pin channel 1 / 2 of universal input card (KRN-UI2) depending on input specification as below figure.

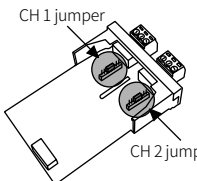

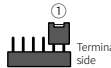
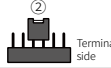
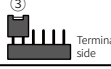
Jumper pin setting	Input specification	Input disconnection alarm
 Terminal side	0 to 20 mA, 4 to 20 mA	4 to 20 mA
 Terminal side	TC, RTD, ± 60 mV, ± 200 mV	○
 Terminal side	± 2 V, 1 to 5 V, ± 5 V, -1 to 10 V	×

Connections

Based on the back of KRN100-04000-00-0S

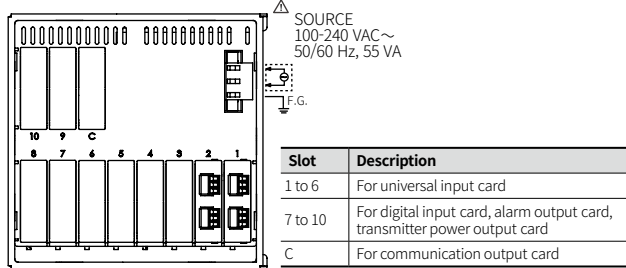

Dimensions

• Unit: mm, For the detailed drawings, follow the Autonics website.

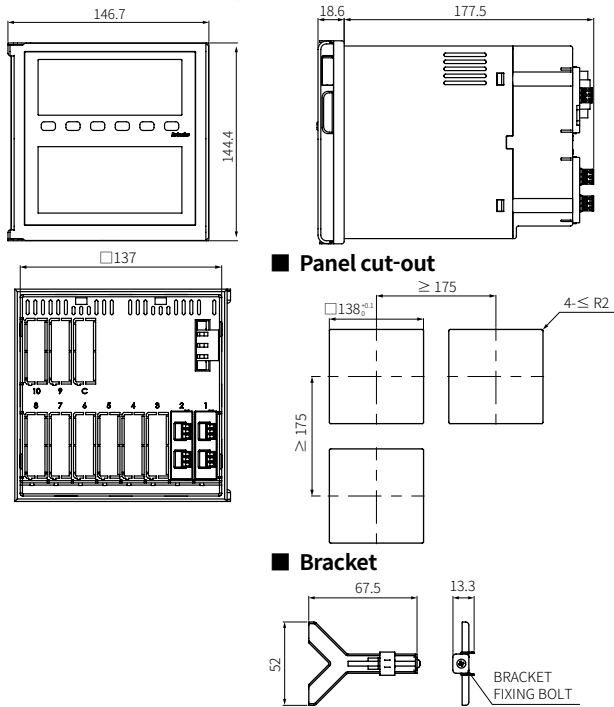

Mode Setting

