

Description

- 5 m sensing range
- 16 to 64 parallel beams
- 28 or 56 mm beam spacing
- Active height of 425 mm to 1770 mm
- Length of 570 mm to 2105 mm
- Flexible cable
- Plug connection to controller
- Slim line (10x28 mm) or leading edge (37,5x13 mm) housing
- Power indicator
- Static and dynamic applications



The SpaceGuard SG 11 light curtain series, which consists of a transmitter SGT and receiver SGR, is made to operate in conjunction with a controller SGC 11. The light curtains are housed in an aluminium profile available in a slim line design (10 x 28 mm) or a leading edge design (37,5 x 13 mm). The system can be used both in static and dynamic installations.

Technical Data

		28 mm channel spacing		56 mm channel spacing	
		SGT	SGR	SGT	SGR
Light source		Infrared (940 nm)	-	Infrared (940 nm)	-
Number of channels (diodes per detector)		16, 24, 32, 48, 56 or 64		16, 24 or 32	
Number of parallel beams		16, 24, 32, 48, 56 or 64		16, 24 or 32	
Active height		425, 650, 875, 1100, 1320, 1545 or 1770 mm		845, 1295 or 1740 mm	
Channel spacing		28 mm		56 mm	
Bottom spacing to Ch 1		22 mm			
Power on indicator		Red LED			
Housing dimensions (w x d)		Slim Line A		10 x 28 mm	
		Leading Edge B		37,5 x 13 mm	
Housing material		Profile		Aluminium (black anodised)	
		Lens cover		Acrylic (A housing) / Polycarbonate (B housing)	
Connection		5 pin, 240° DIN plug	5 pin, 180° DIN plug	5 pin, 240° DIN plug	5 pin, 180° DIN plug
Cable, PUR Ø 5,2 mm		5 x 0,14 mm ²			

Environmental Data

		SGT	SGR
Light immunity @ 20° incidence		-	10 000 lux
Temperature, operation		-20 to +55 °C	
Temperature, storage		-40 to +80 °C	
Sealing class A / B housing		IP 54	
Approvals		CE UK EA	

Available Types

Slim Line A

	Housing Length	Active Height	Connection		4 m flexible cable	0.5 m flexible cable	Range
			No of Beams	Beam Spacing	Order Reference		
Transmitter	570 mm	425 mm	16	28 mm	SGT 057-016-A1-A-4F	SGT 057-016-A1-A-0.5F	5 m
	795 mm	650 mm	24		SGT 080-024-A1-A-4F	SGT 080-024-A1-A-0.5F	
	1020 mm	845 mm	16	28 mm	SGT 102-016-B1-A-4F	SGT 102-016-B1-A-0.5F	
		875 mm	32		SGT 102-032-A1-A-4F	SGT 102-032-A1-A-0.5F	
	1245 mm	1100 mm	40	SGT 125-040-A1-A-4F	SGT 125-040-A1-A-0.5F		
	1470 mm	1295 mm	24	28 mm	SGT 147-024-B1-A-4F	SGT 147-024-B1-A-0.5F	
		1320 mm	48		SGT 147-048-A1-A-4F	SGT 147-048-A1-A-0.5F	
	1695 mm	1545 mm	56	SGT 170-056-A1-A-4F	SGT 170-056-A1-A-0.5F		
	1995 mm	1740 mm	32	28 mm	SGT 200-032-B1-A-4F	SGT 200-032-B1-A-0.5F	
		1770 mm	64		SGT 200-064-A1-A-4F	SGT 200-064-A1-A-0.5F	
	2105 mm	1740 mm	32	28 mm	SGT 210-032-B1-A-4F	SGT 210-032-B1-A-0.5F	
		1770 mm	64		SGT 210-064-A1-A-4F	SGT 210-064-A1-A-0.5F	

Receiver	570 mm	425 mm	16	28 mm	SGR 057-016-A1-A-4F	SGR 057-016-A1-A-0.5F	5 m
	795 mm	650 mm	24		SGR 080-024-A1-A-4F	SGR 080-024-A1-A-0.5F	
	1020 mm	845 mm	16	28 mm	SGR 102-016-B1-A-4F	SGR 102-016-B1-A-0.5F	
		875 mm	32		SGR 102-032-A1-A-4F	SGR 102-032-A1-A-0.5F	
	1245 mm	1100 mm	40	SGR 125-040-A1-A-4F	SGR 125-040-A1-A-0.5F		
	1470 mm	1295 mm	24	28 mm	SGR 147-024-B1-A-4F	SGR 147-024-B1-A-0.5F	
		1320 mm	48		SGR 147-048-A1-A-4F	SGR 147-048-A1-A-0.5F	
	1695 mm	1545 mm	56	SGR 170-056-A1-A-4F	SGR 170-056-A1-A-0.5F		
	1995 mm	1740 mm	32	28 mm	SGR 200-032-B1-A-4F	SGR 200-032-B1-A-0.5F	
		1770 mm	64		SGR 200-064-A1-A-4F	SGR 200-064-A1-A-0.5F	
	2105 mm	1740 mm	32	28 mm	SGR 210-032-B1-A-4F	SGR 210-032-B1-A-0.5F	
		1770 mm	64		SGR 210-064-A1-A-4F	SGR 210-064-A1-A-0.5F	

Leading Edge B

Transmitter	570 mm	425 mm	16	28 mm	SGT 057-016-A1-B-4F	SGT 057-016-A1-B-0.5F	3.5 m
	795 mm	650 mm	24		SGT 080-024-A1-B-4F	SGT 080-024-A1-B-0.5F	
	1020 mm	845 mm	16	28 mm	SGT 102-016-B1-B-4F	SGT 102-016-B1-B-0.5F	
		875 mm	32		SGT 102-032-A1-B-4F	SGT 102-032-A1-B-0.5F	
	1245 mm	1100 mm	40	SGT 125-040-A1-B-4F	SGT 125-040-A1-B-0.5F		
	1470 mm	1295 mm	24	28 mm	SGT 147-024-B1-B-4F	SGT 147-024-B1-B-0.5F	
		1320 mm	48		SGT 147-048-A1-B-4F	SGT 147-048-A1-B-0.5F	
	1695 mm	1545 mm	56	SGT 170-056-A1-B-4F	SGT 170-056-A1-B-0.5F		
	1995 mm	1740 mm	32	28 mm	SGT 200-032-B1-B-4F	SGT 200-032-B1-B-0.5F	
		1770 mm	64		SGT 200-064-A1-B-4F	SGT 200-064-A1-B-0.5F	
	2105 mm	1740 mm	32	28 mm	SGT 210-032-B1-B-4F	SGT 210-032-B1-B-0.5F	
		1770 mm	64		SGT 210-064-A1-B-4F	SGT 210-064-A1-B-0.5F	

Receiver	570 mm	425 mm	16	28 mm	SGR 057-016-A1-B-4F	SGR 057-016-A1-B-0.5F	3.5 m
	795 mm	650 mm	24		SGR 080-024-A1-B-4F	SGR 080-024-A1-B-0.5F	
	1020 mm	845 mm	16	28 mm	SGR 102-016-B1-B-4F	SGR 102-016-B1-B-0.5F	
		875 mm	32		SGR 102-032-A1-B-4F	SGR 102-032-A1-B-0.5F	
	1245 mm	1100 mm	40	SGR 125-040-A1-B-4F	SGR 125-040-A1-B-0.5F		
	1470 mm	1295 mm	24	28 mm	SGR 147-024-B1-B-4F	SGR 147-024-B1-B-0.5F	
		1320 mm	48		SGR 147-048-A1-B-4F	SGR 147-048-A1-B-0.5F	
	1695 mm	1545 mm	56	SGR 170-056-A1-B-4F	SGR 170-056-A1-B-0.5F		
	1995 mm	1740 mm	32	28 mm	SGR 200-032-B1-B-4F	SGR 200-032-B1-B-0.5F	
		1770 mm	64		SGR 200-064-A1-B-4F	SGR 200-064-A1-B-0.5F	
	2105 mm	1740 mm	32	28 mm	SGR 210-032-B1-B-4F	SGR 210-032-B1-B-0.5F	
		1770 mm	64		SGR 210-064-A1-B-4F	SGR 210-064-A1-B-0.5F	

- Note: 1. The transmitter SGT and the receiver SGR set must always have the same number of light beams and the same beam spacing.
 2. Special lengths are available upon request.
 3. Special epoxy moulding for IP 65 rating, in Slim Line A-profile, is available upon request.

Dimensions and Descriptions

Slim Line A

Details

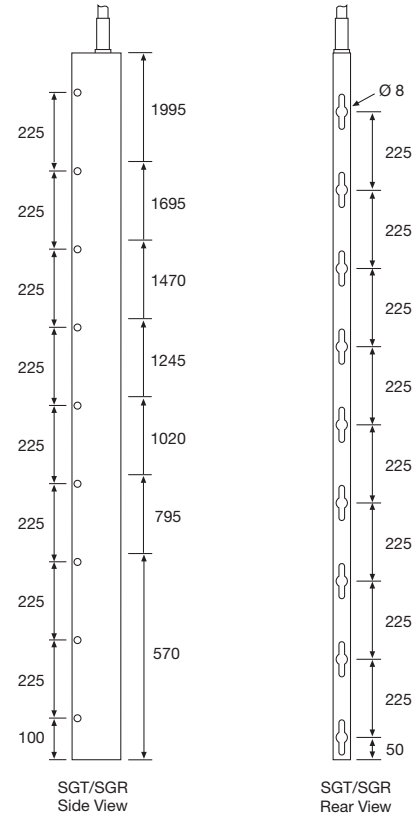
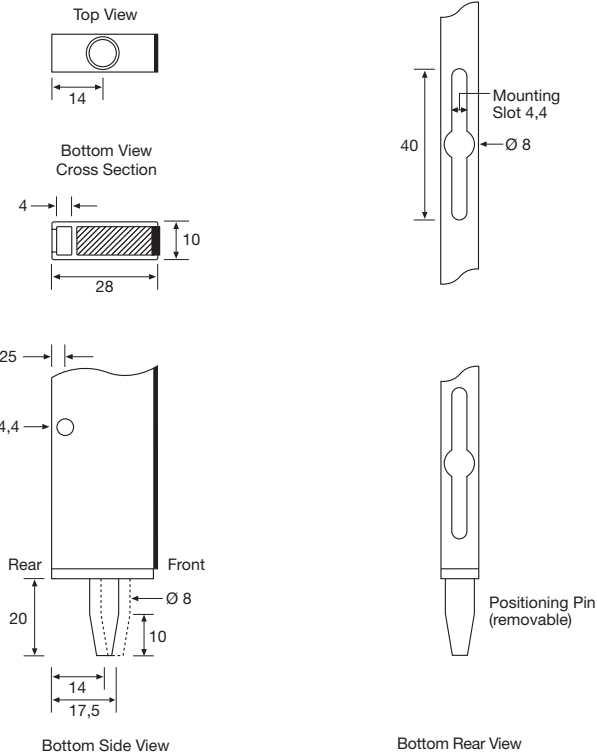
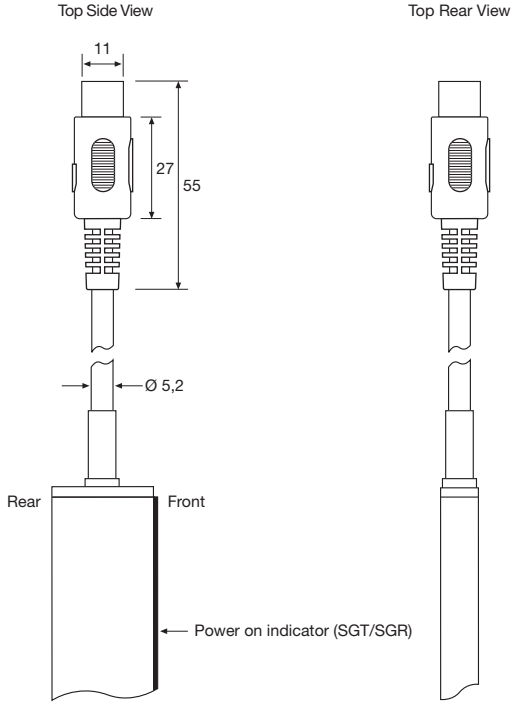

SGT/SGR 057 to 200

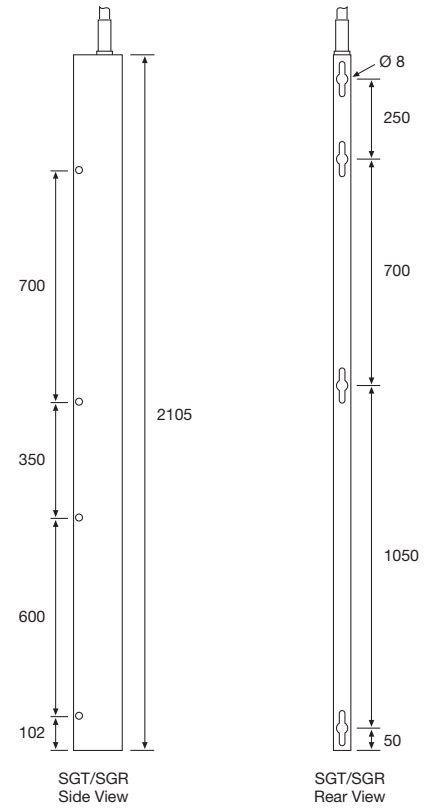

SGT/SGR 210

(Units in mm)

Dimensions and Descriptions

Leading Edge B

Details

SGT
Top Front View
(shown with screw cover strip)

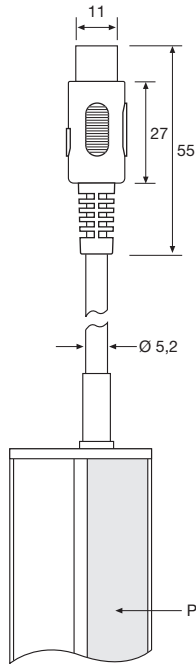

SGR
Top Front View
(shown without screw cover strip)

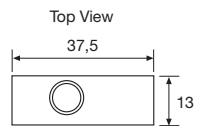
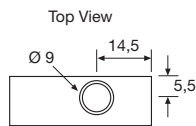
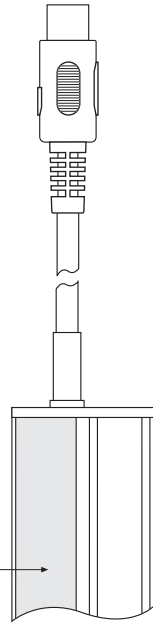

Bottom View
Cross Section

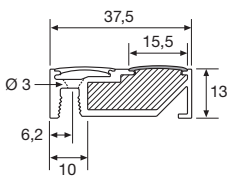

Bottom View
Cross Section

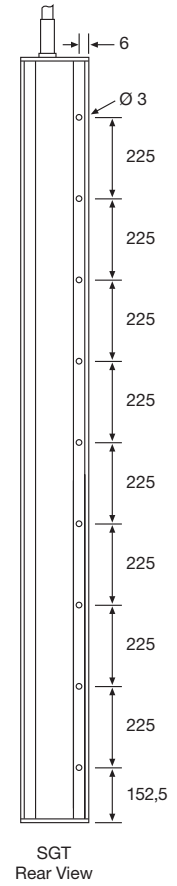
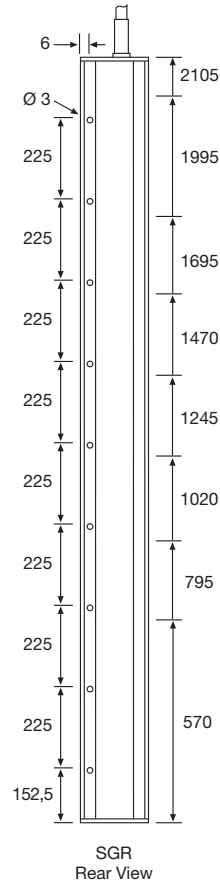
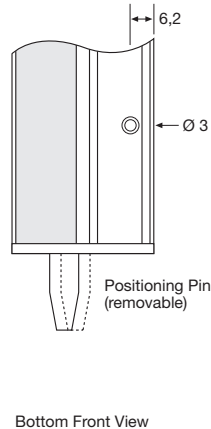
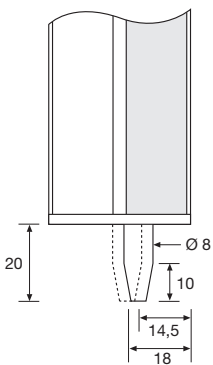
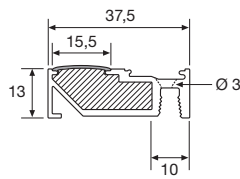

SGT/SGR 057 to 210

(Units in mm)

Beam Patterns

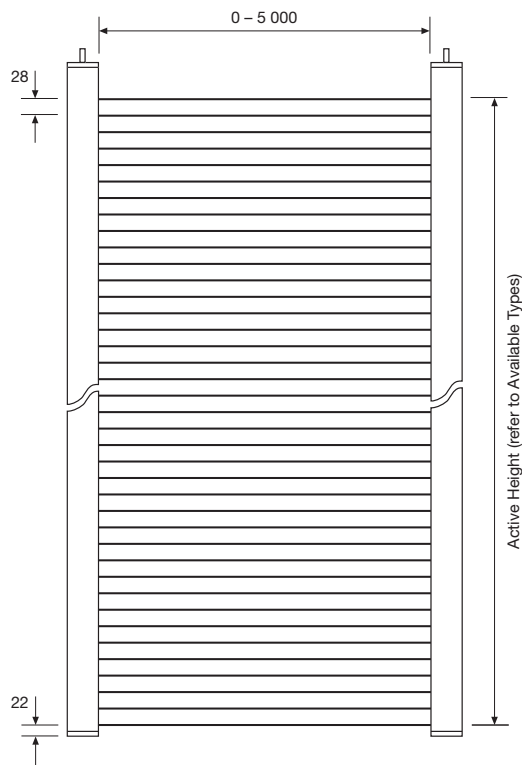

28 mm channel spacing

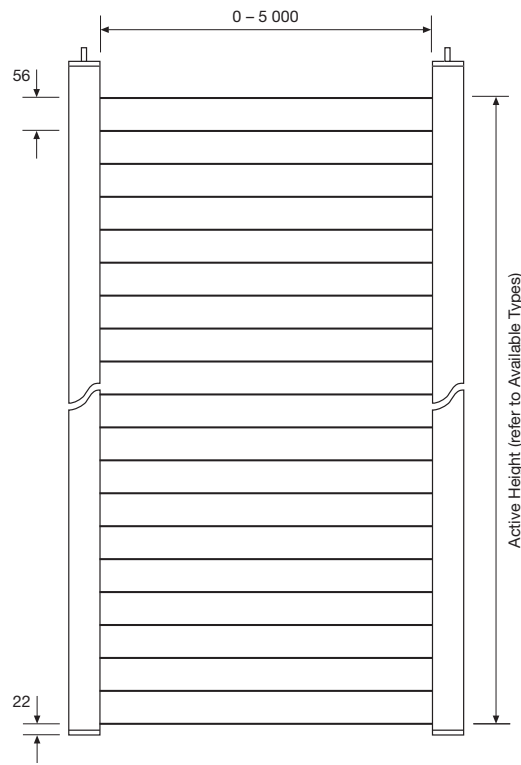

56 mm channel spacing

(Units in mm)

Sensing Characteristics

Parallel Displacement

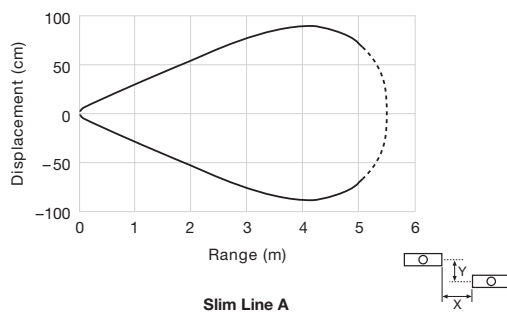

Extension Cables

Dimension Drawing (Units in mm)	Cable Type	Installation	Sealing Class	Length	Connector	Transmitter	Receiver
						5 pin, 240° DIN plug	5 pin, 180° DIN plug
Material						Order Reference	
	Flexible	Dynamic and Static	IP 67	4 m	PUR	CBG 5 S 4	CBH 5 S 4

Telco reserves the right to change specifications without notice.